

# Flynn

# SITS



# Flynn

designed by: Steven Schilte



## UPHOLSTERY



fabric

## COMFORTS



lux

## COVERS



loose with  
velcro

## SPECIAL



modular  
system

All elements are freestanding.

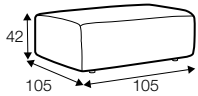

footstool 105x105

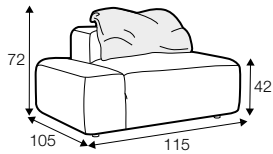

element 115 left or / right  
with back cushion 75x65

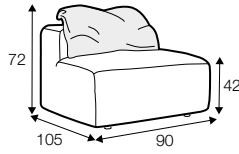

element 90 without armrests  
with back cushion 75x65

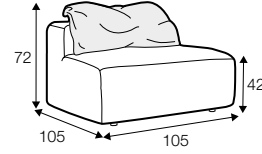

element 105 without armrests  
with back cushion 90x65

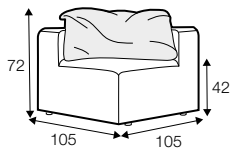

corner 90°  
with back cushion 90x65

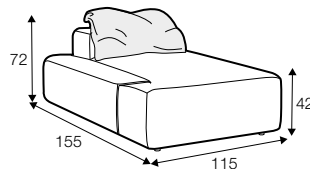

chaiselongue left or / right  
with back cushion 75x65

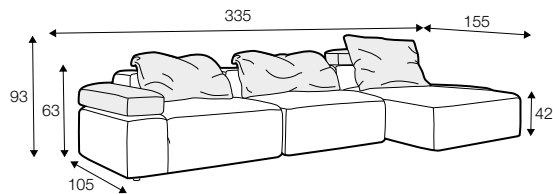

## example set

element 115 left / or right with back cushion 75x65  
+ armrest / headrest 103 + element 105 without armrests  
with back cushion 90x65 + chaiselongue right / or left  
with back cushion 75x65 + armrest / headrest 88

## extra dimensions

---

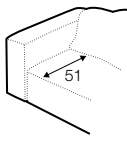

depth of seat

## accessories

---

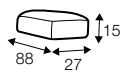
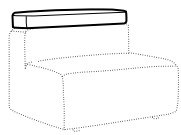
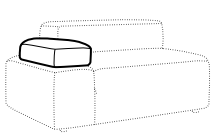

armrest / headrest 88

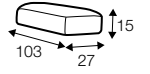
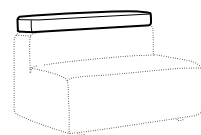
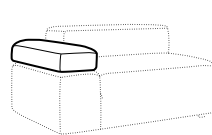

armrest / headrest 103

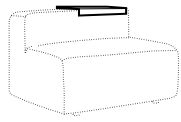
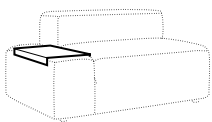

metal tray 50x27  
soft touch, black



back cushion 75x65

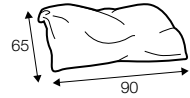

back cushion 90x65

## legs

---

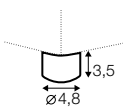

no. 173  
wood

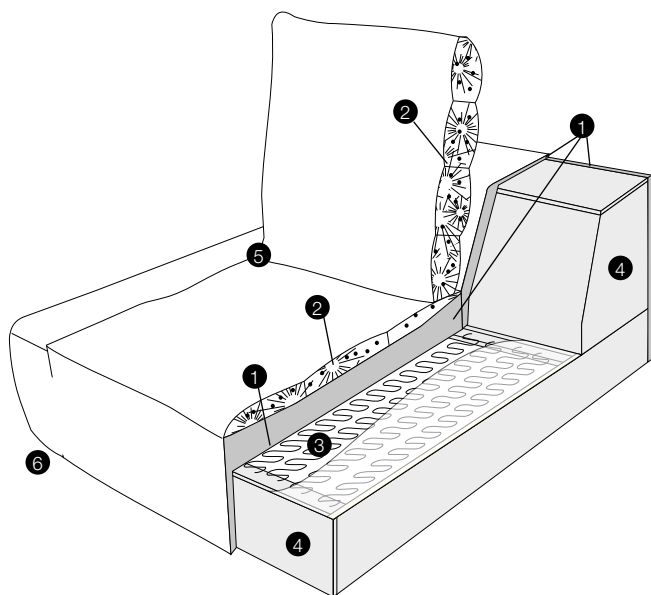

lux

1. polyurethane foam/high resilient polyurethane foam
2. cushion chamber with mix of feather and silicone balls
3. springs
4. FSC® certified solid wood and wood based elements
5. fabric
6. FSC® certified solid wood or metal legs