

VISION 20/20

THE EYE LIGHT

DCWéditions
PARIS



© Bureau Mine

Our eyes are under increased levels of stress.

5 hours a day, our eyes are glued to screens.

From the age of 30, visual fatigue can appear.

Vision does not tolerate mediocrity.

WITHOUT good lighting:

- _ Eyes are itchy/ stinging**
- _ Reading time reduces**
- _ Headaches appear**

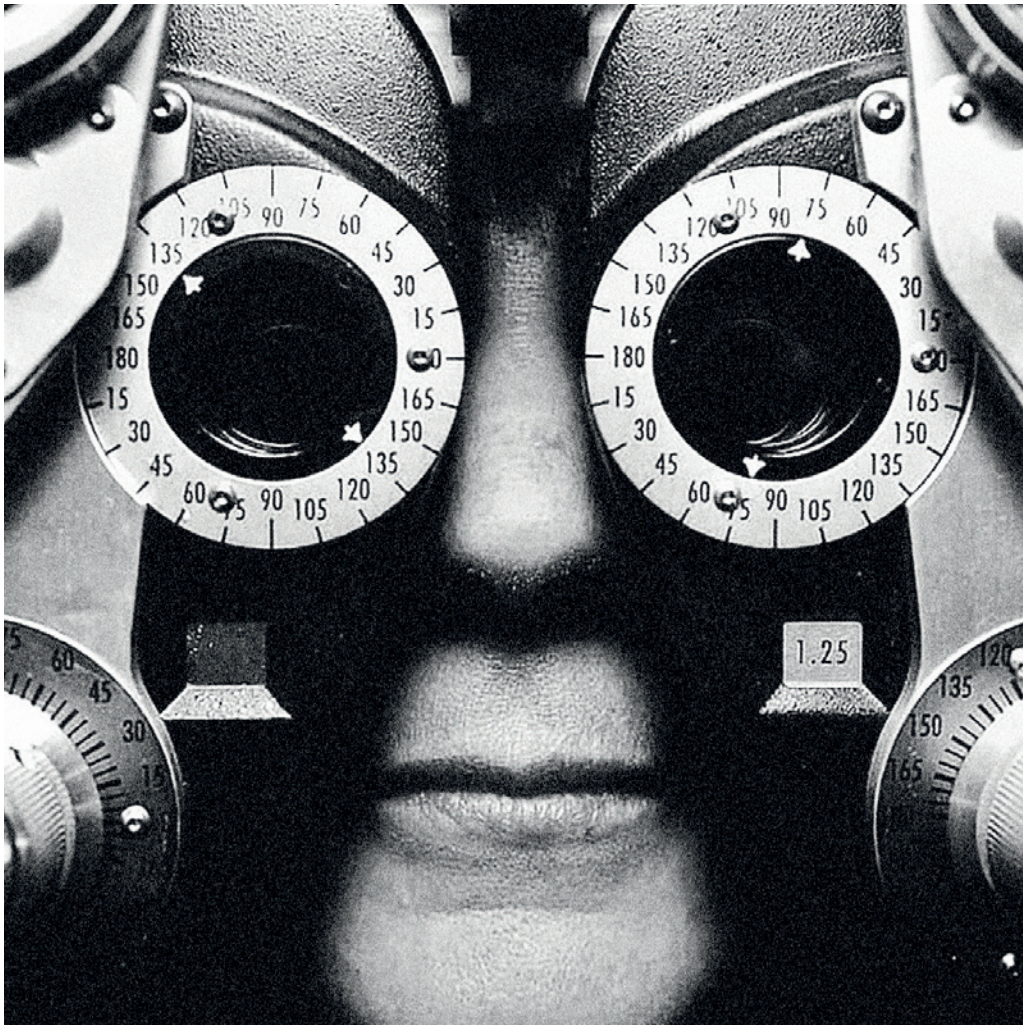

The performance of
Vision 20/20
allows you to:

- 1.** Illuminate your spaces with precision
- 2.** Adjust the light intensity to suit your eyesight
- 3.** Reduce glare from tablets

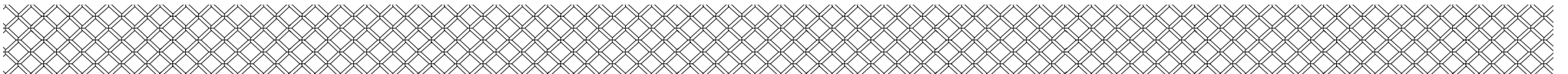

COLLECTION VISION 20/20

FLOOR LAMP

« the heroine »

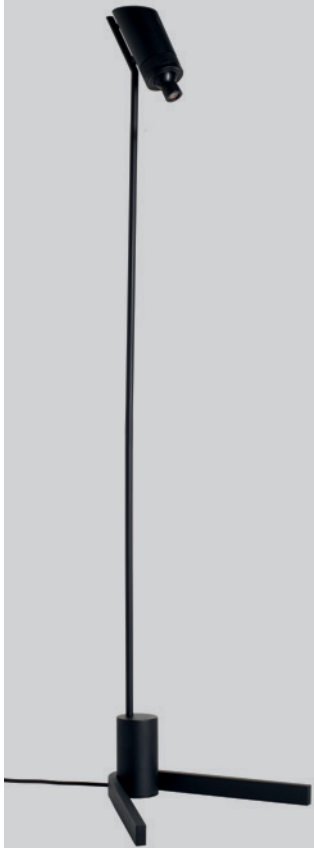

VISION 20/20 FLOOR

BEDSIDE LAMP



**VISION 20/20
OMNI**



**VISION 20/20
OMNI SWITCH**



VISION 20/20



VISION 20/20 SWITCH

ACCESSORIES



CABLE KIT
VISION 20/20
for
**VISION 20/20 OMNI
& OMNI SW**



CABLE KIT
VISION 20/20
for
VISION 20/20



CABLE KIT
VISION 20/20
for
VISION 20/20 SW

FLOOR LAMP

VISION 20/20 FLOOR

« the heroine »

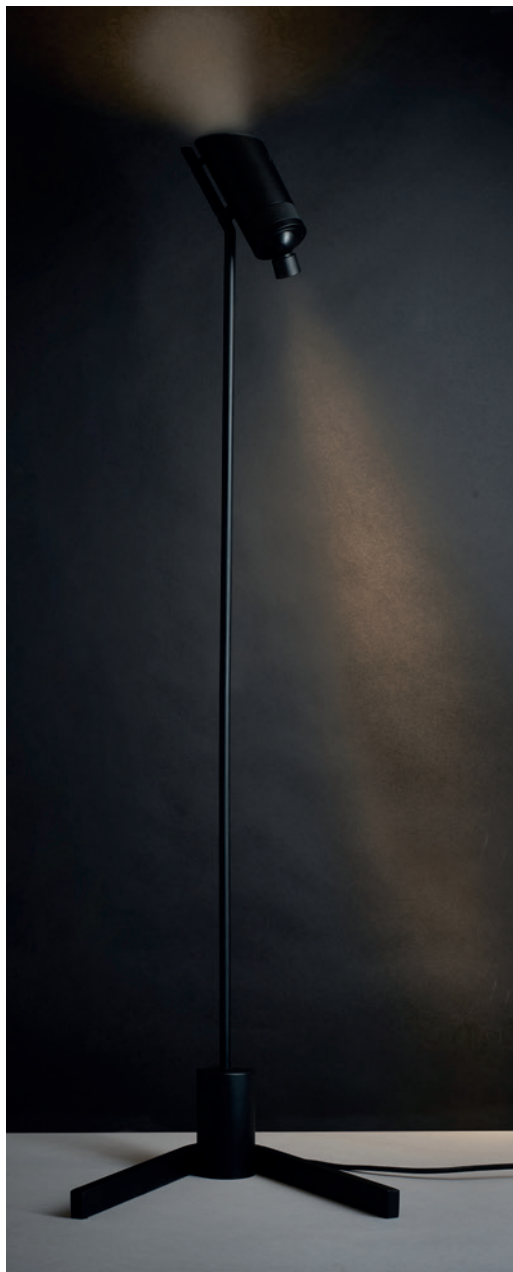

FLOOR LAMP

VISION 20/20 FLOOR « the heroine »

VISION 20/20 FLOOR

TECHNICAL SHEET

Source	integrated LED - 2700 K
Lumen	390 Lm
Driver	2 integrated drivers
Switch	<ul style="list-style-type: none">• 1 touch dimmer for top lighting• 1 rotating dimmer for bottom lighting
Dimensions (mm)	height: 1370, depth: 307, width: 332
Class	II
Materials	aluminium, steel
Finish	black

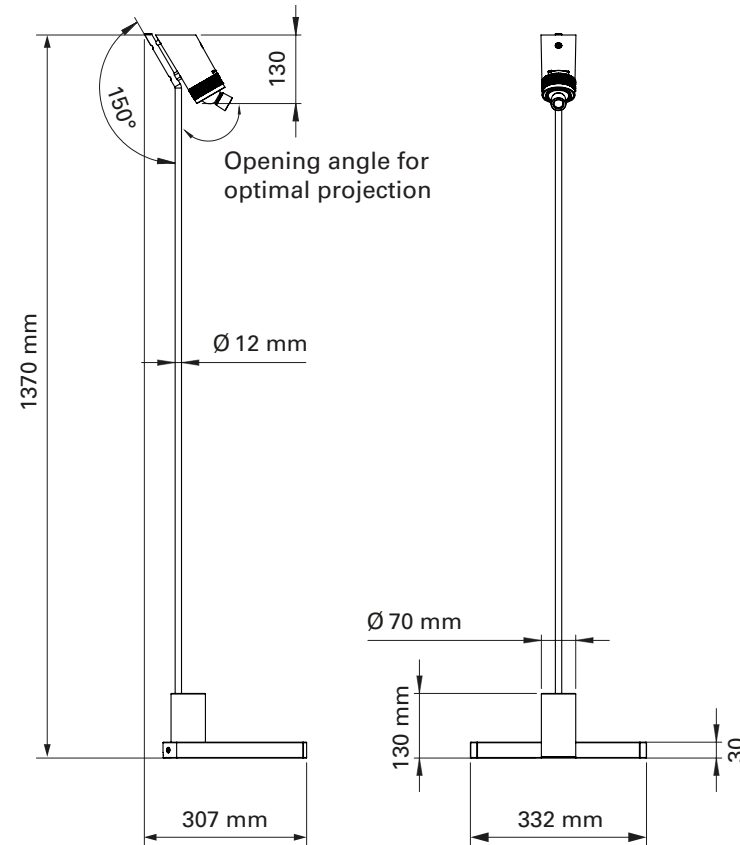

The angle of the foot fits perfectly behind a sofa, an armchair or under a bed





BEDSIDE LAMPS

VISION 20/20 OMNI VISION 20/20 OMNI SW *2 sources of light*

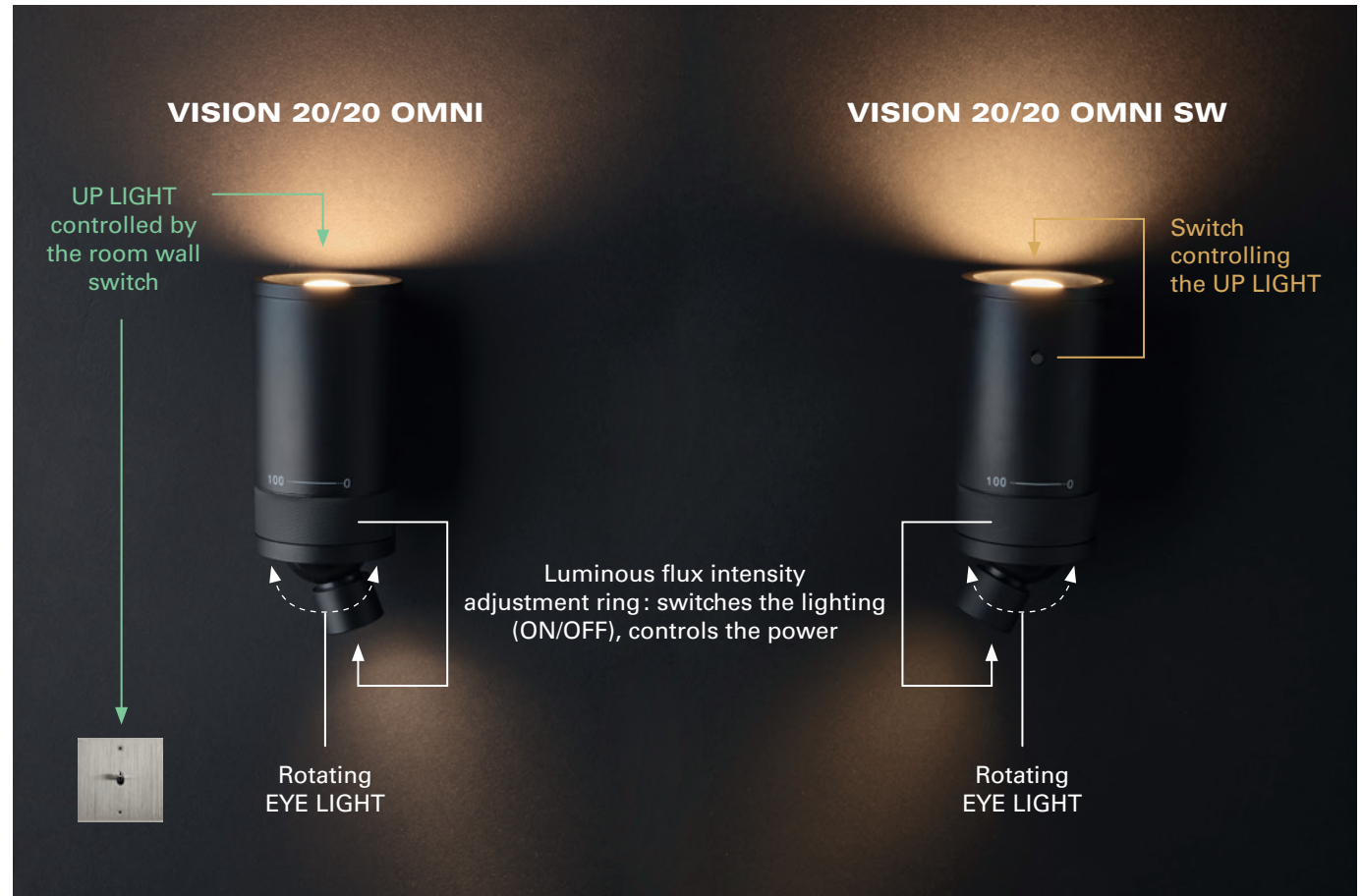

BEDSIDE LAMPS

VISION 20/20 OMNI VISION 20/20 OMNI SW *2 sources of light*

VISION 20/20 OMNI VISION 20/20 OMNI SW

TECHNICAL SHEET

Source	integrated LED - 2700 K
Lumen	390 Lm
Driver 1	integrated driver for UP LIGHT
Driver 2*	external driver (77x45x26 mm) in the wall or to be moved to the electrical panel
Switch (OMNI)	<ul style="list-style-type: none"> • wall switch required for UP LIGHT • rotating dimmer for EYE LIGHT
Switch (OMNI SW)	<ul style="list-style-type: none"> • ON/OFF for UP LIGHT • rotating dimmer for EYE LIGHT
Dimensions (mm)	height: 120.5 ; depth: 60 ; width: 71
Class	II
Material	aluminium
Finish	black

* In a different case, see ACCESSORIES - CABLE SET section

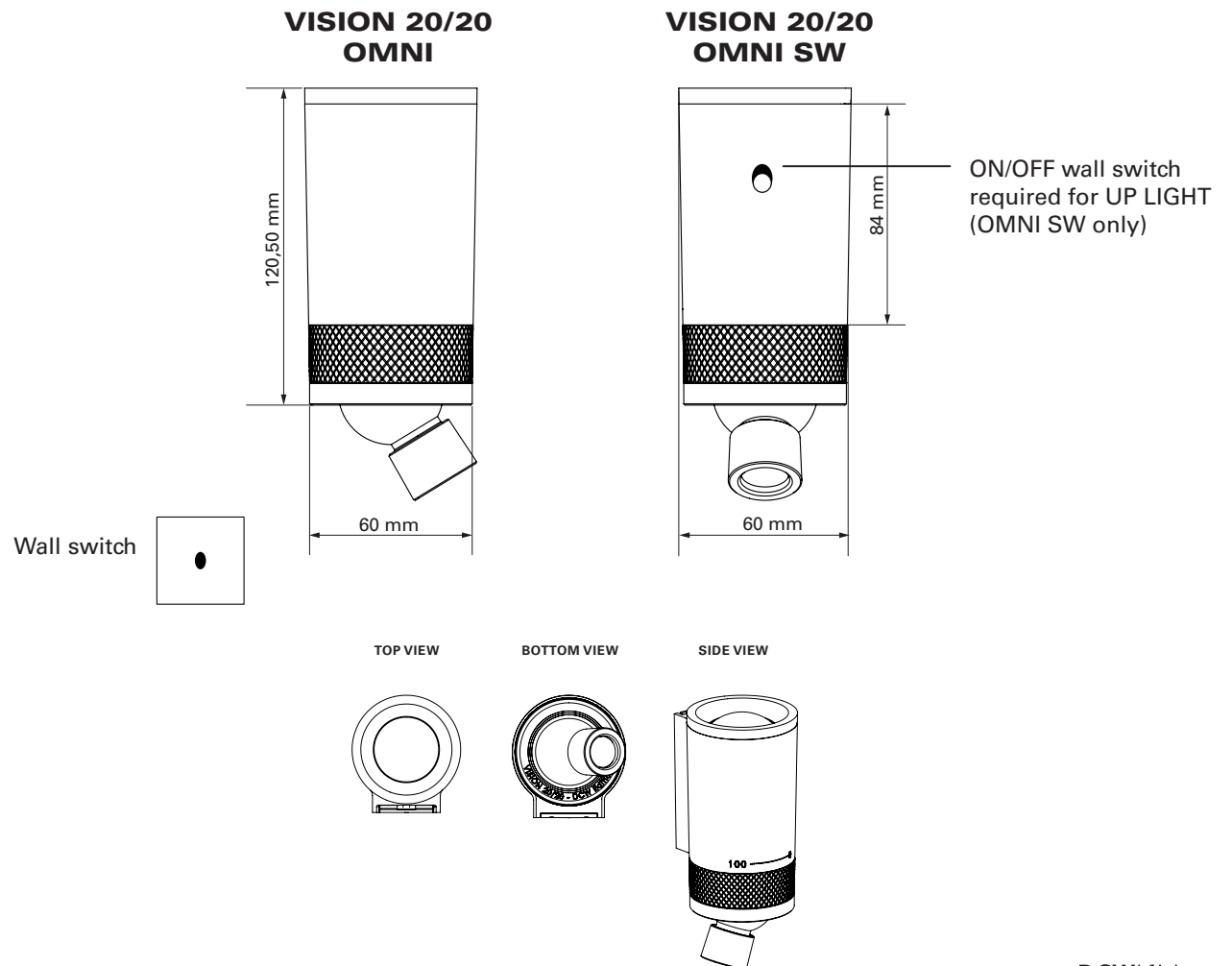

COVER PLATE VISION 20/20 OMNI VISION 20/20 OMNI SW

If you have a $\varnothing 68$ mm junction box, the **COVER PLATE** allows to cover it

COVER PLATE VISION 20/20 OMNI
& VISION 20/20 OMNI SW

TECHNICAL SHEET

Accessory	accessory for VISION 20/20 OMNI & VISION 20/20 OMNI SW
Use	used to cover the CE junction box
Dimensions (mm)	length : 96 ; width : 75
Material	steel
Finish	black

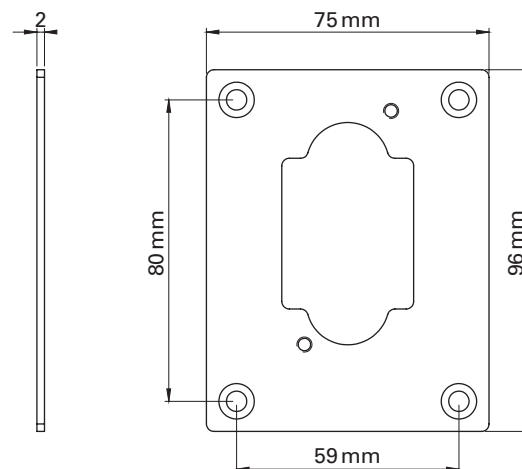

FITTING INSTRUCTIONS FOR BEDSIDE LAMPS

VISION 20/20 OMNI

VISION 20/20 OMNI

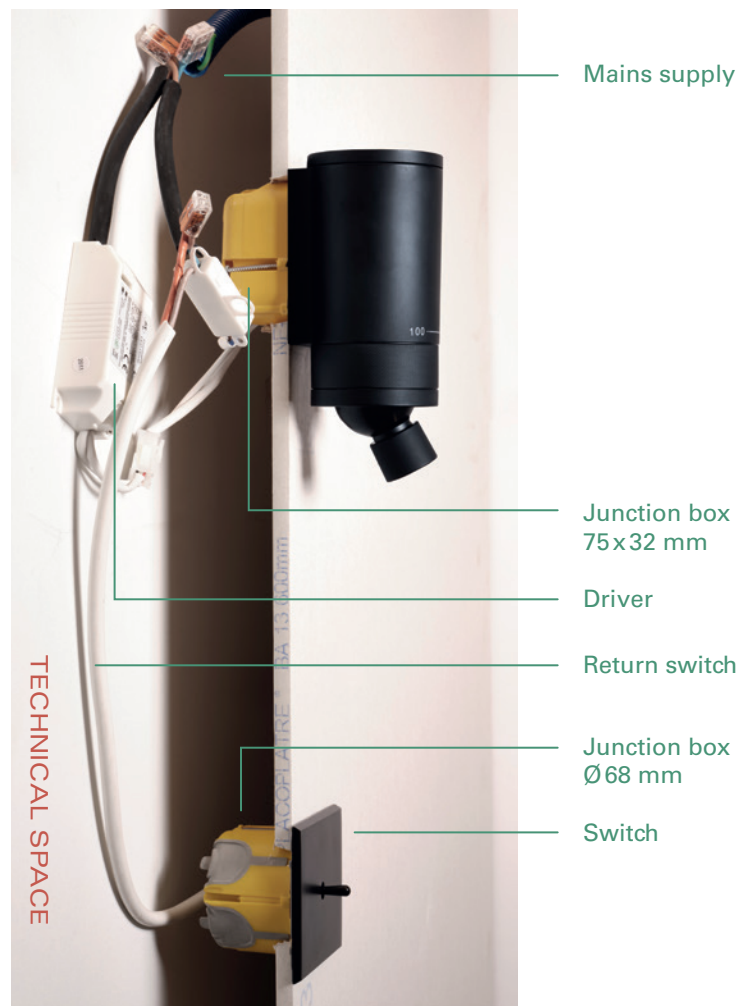

VISION 20/20 OMNI
with separated driver

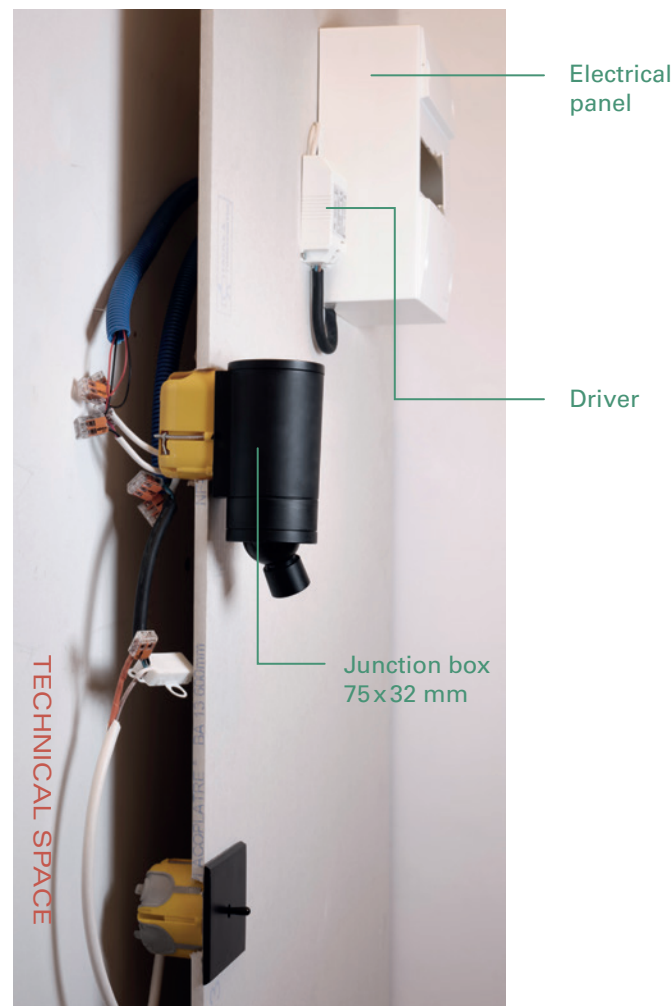

VISION 20/20 OMNI
with junction box Ø68 mm,
use the COVER PLATE

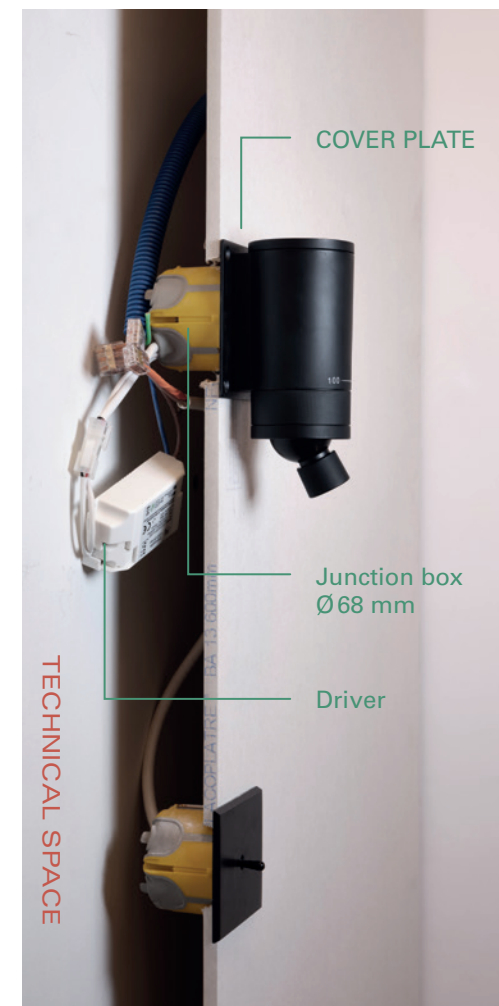

FITTING INSTRUCTIONS FOR BEDSIDE LAMPS

VISION 20/20 OMNI SW

VISION 20/20 OMNI SW



VISION 20/20 OMNI SW
with separated driver

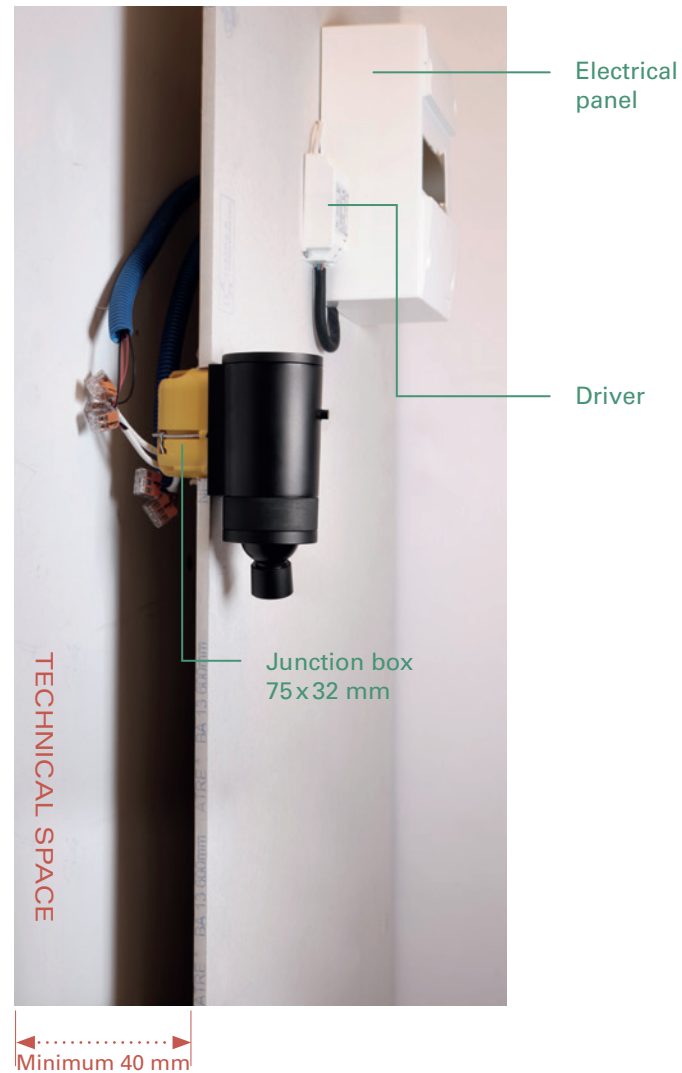

VISION 20/20 OMNI SW
with junction box Ø 68 mm,
use the COVER PLATE

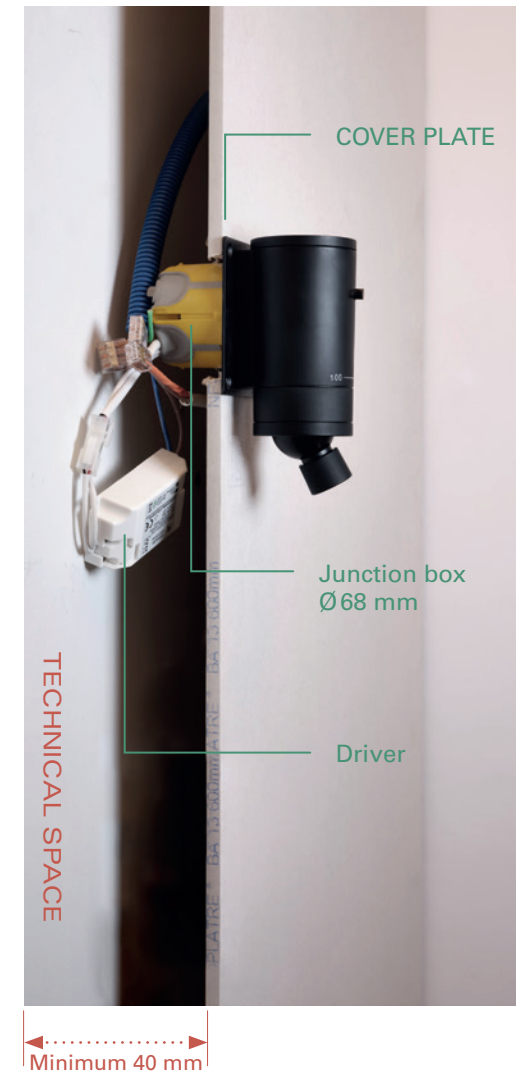



1 mt distance between the mattress and the top of the lamp

VISION 20/20 OMNI SW

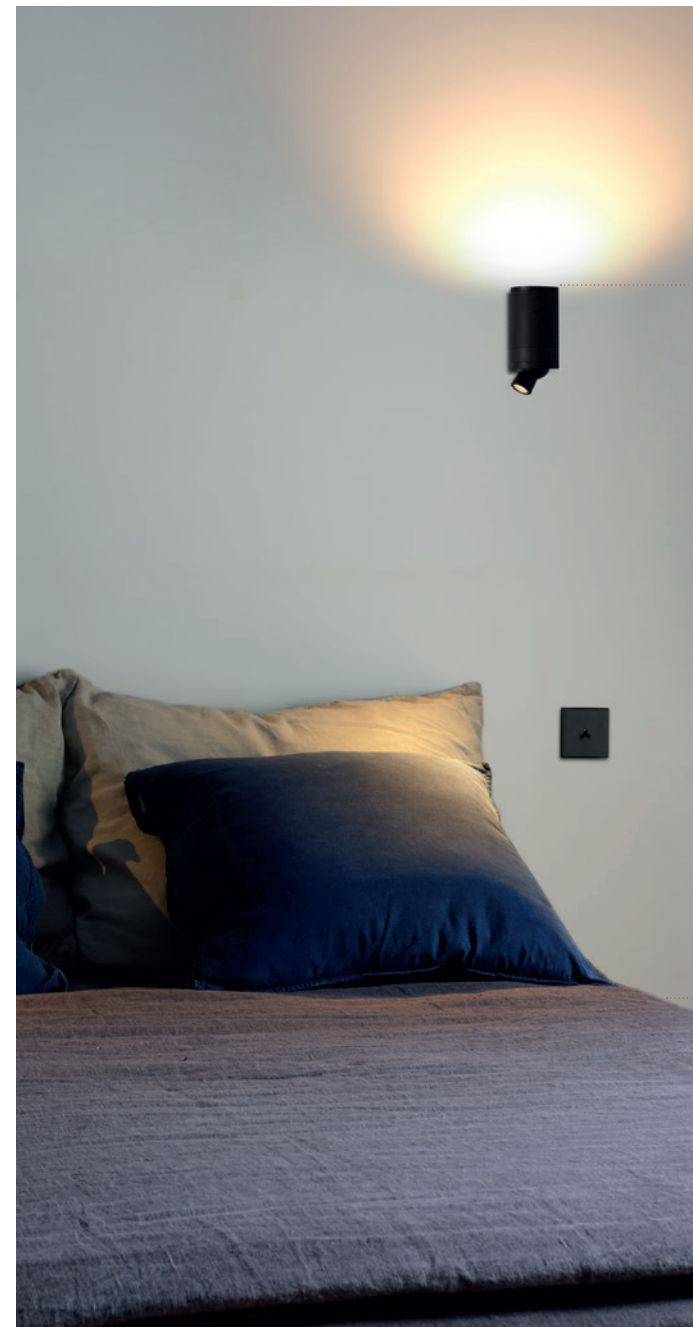

1 mt distance between the mattress and the top of the lamp

VISION 20/20 OMNI activated by a wall switch

BEDSIDE LAMPS

VISION 20/20 VISION 20/20 SW *1 source of light*



BEDSIDE LAMPS

VISION 20/20 VISION 20/20 SW *1 source of light*

VISION 20/20

VISION 20/20 SW

TECHNICAL SHEET

Source	integrated LED - 2700 K
Lumen	150 Lm
Driver (VISION 20/20)	integrated driver
Driver (VISION 20/20 SW)*	external driver (77x45x26 mm) in the wall or to be moved to the electrical panel
Switch (VISION 20/20)	wall switch required
Switch (VISION 20/20 SW)	ON/OFF rotating dimmer
Dimensions (mm)	depth: 77.6 ; width: 60
Class	II
Material	aluminium
Finish	black

* In a different case, see ACCESSORIES - CABLE SET section

VISION 20/20

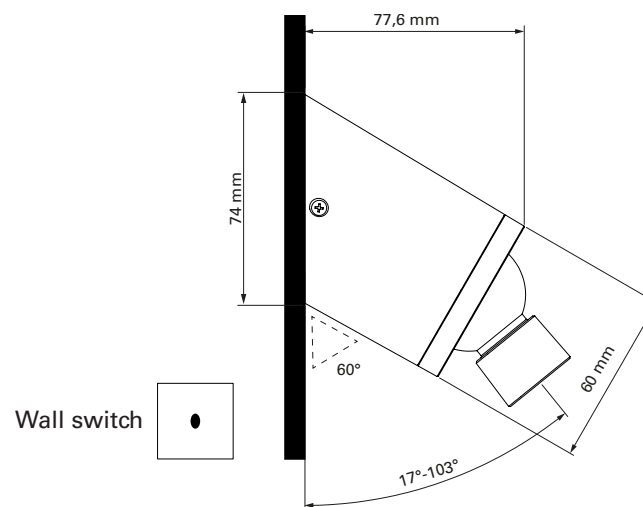

TOP VIEW

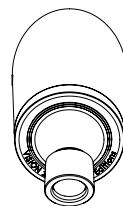

VISION 20/20 SW

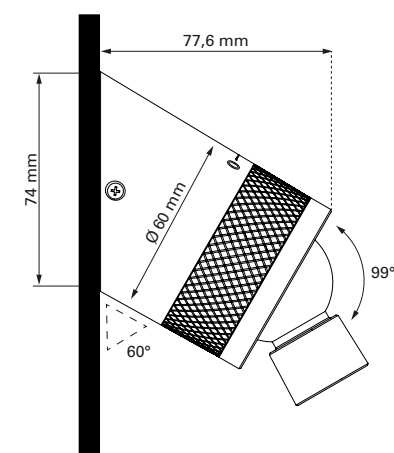

TOP VIEW



BOTTOM VIEW

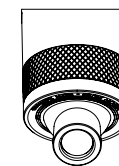

SIDE VIEW



BEDSIDE LAMPS

COVER PLATE VISION 20/20 VISION 20/20 SW

If you have a $\varnothing 68$ mm junction box, the **COVER PLATE** allows to cover it

COVER PLATE VISION 20/20 & VISION 20/20 SW

TECHNICAL SHEET

Accessory	accessory for VISION 20/20 & VISION 20/20 SW
Use	used to cover the CE junction box
Dimensions (mm)	diametre: 100
Material	steel
Finish	black

For the **VISION 20/20** the driver is inside the lamp, no need for the **COVER PLATE** if you have a $\varnothing 54$ mm junction box.

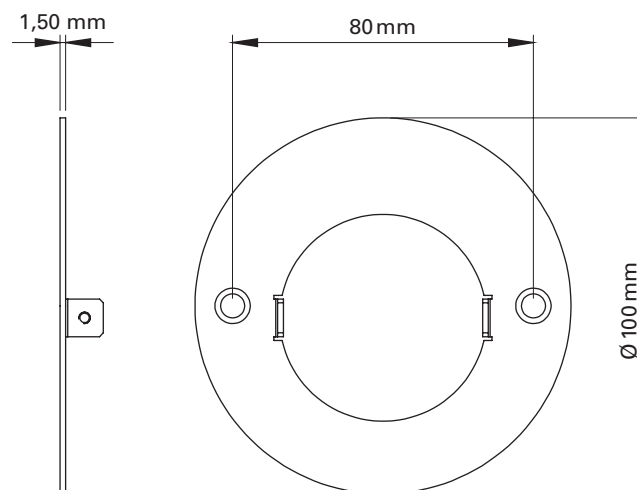

FITTING INSTRUCTIONS FOR BEDSIDE LAMPS

VISION 20/20

VISION 20/20

VISION 20/20
with junction box Ø 68 mm,
use the COVER PLATE

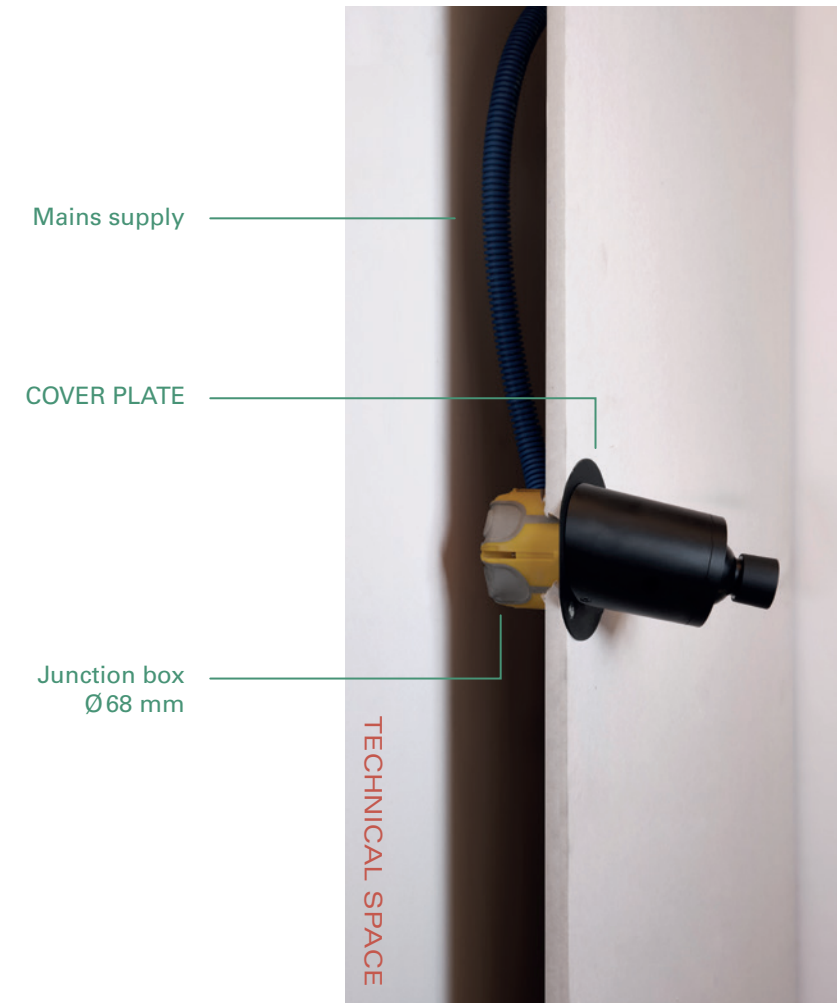
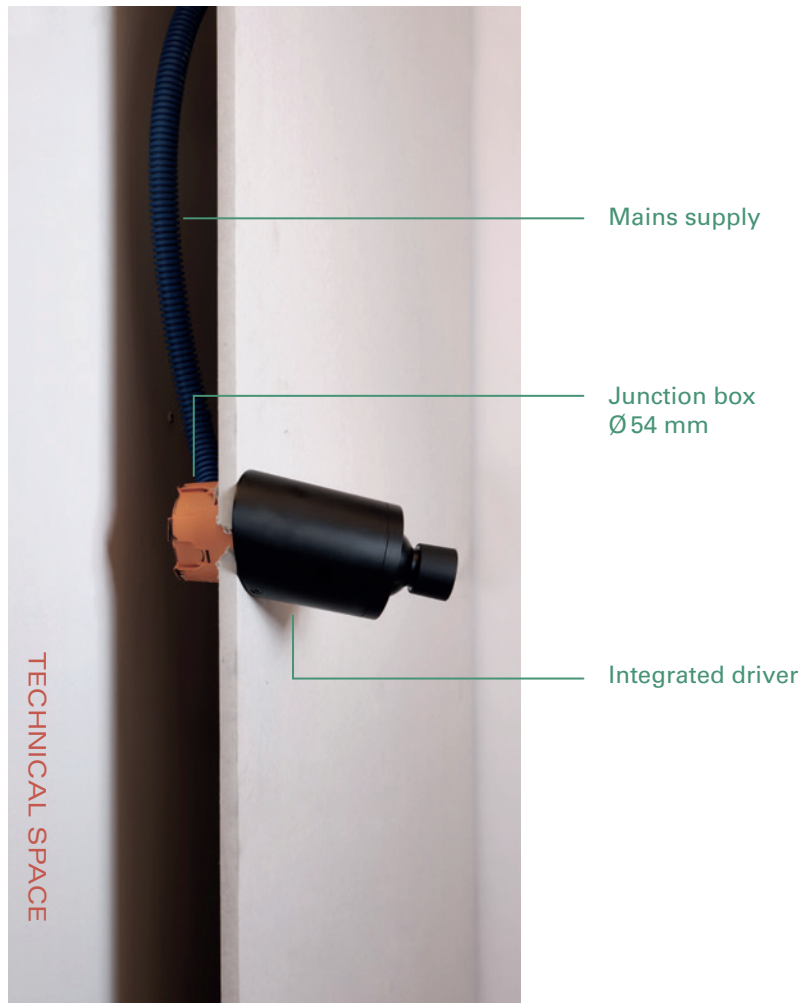

FITTING INSTRUCTIONS FOR BEDSIDE LAMPS

VISION 20/20 SW

VISION 20/20 SW

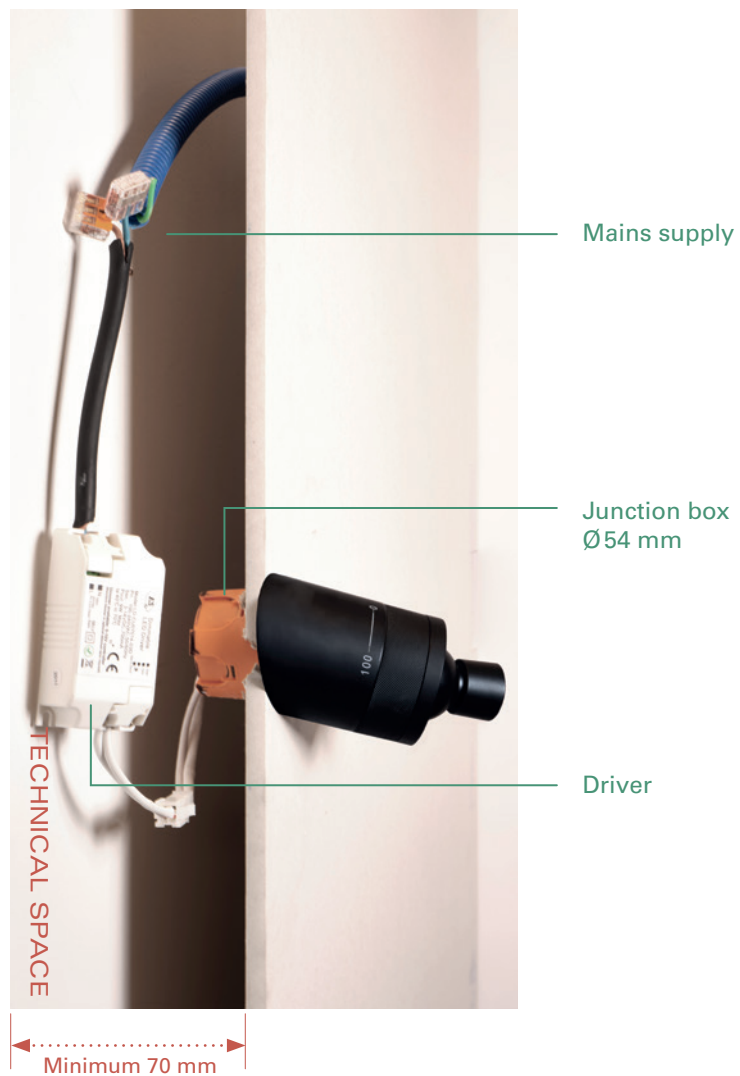

VISION 20/20 SW
with separated driver

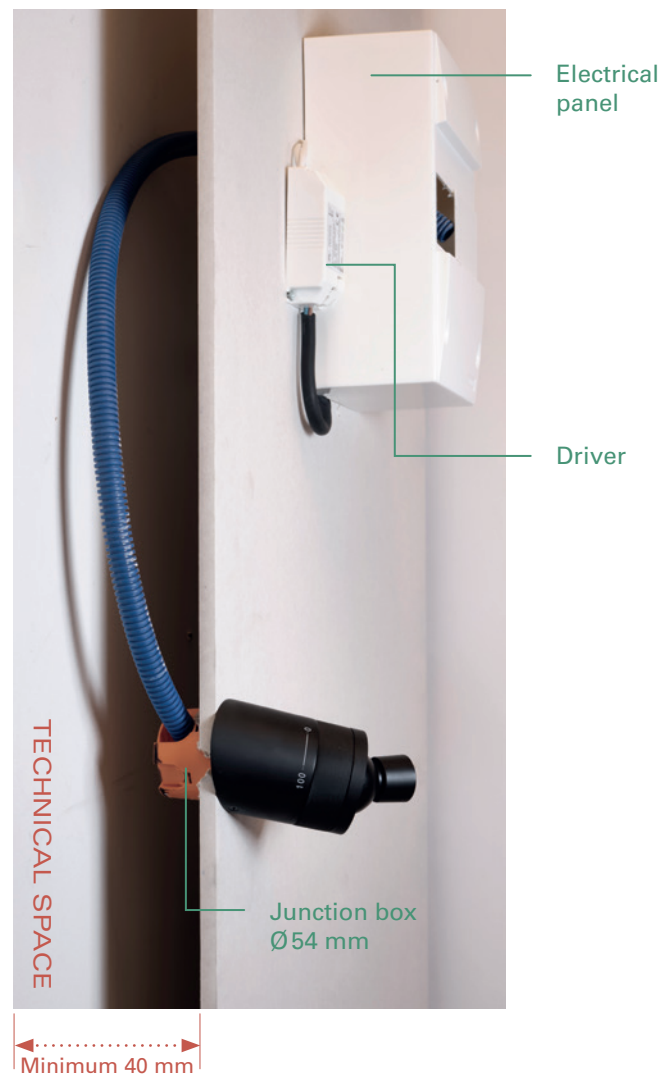

VISION 20/20 SW

with junction box Ø68 mm,
use the COVER PLATE

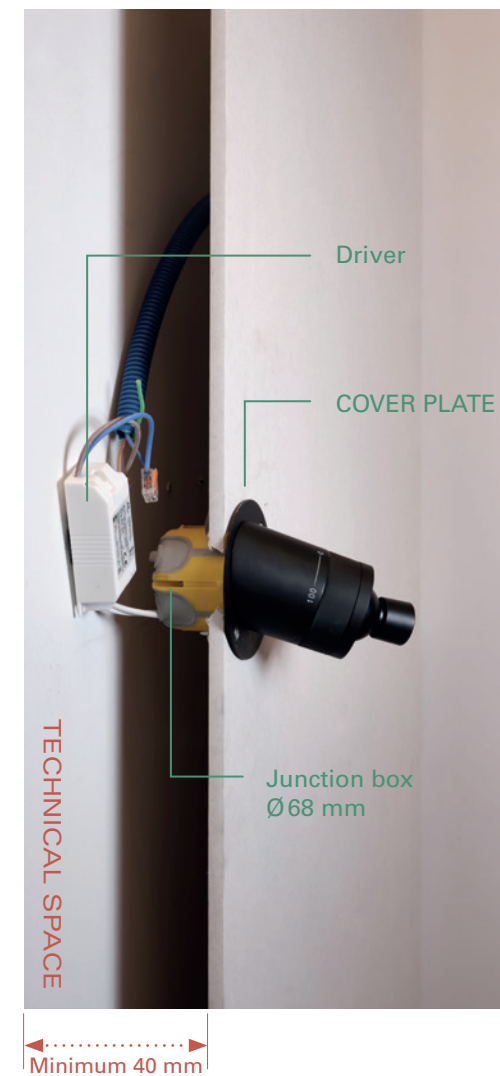



0,75 mt distance between the mattress and the top of the lamp

VISION 20/20 activated by a wall switch

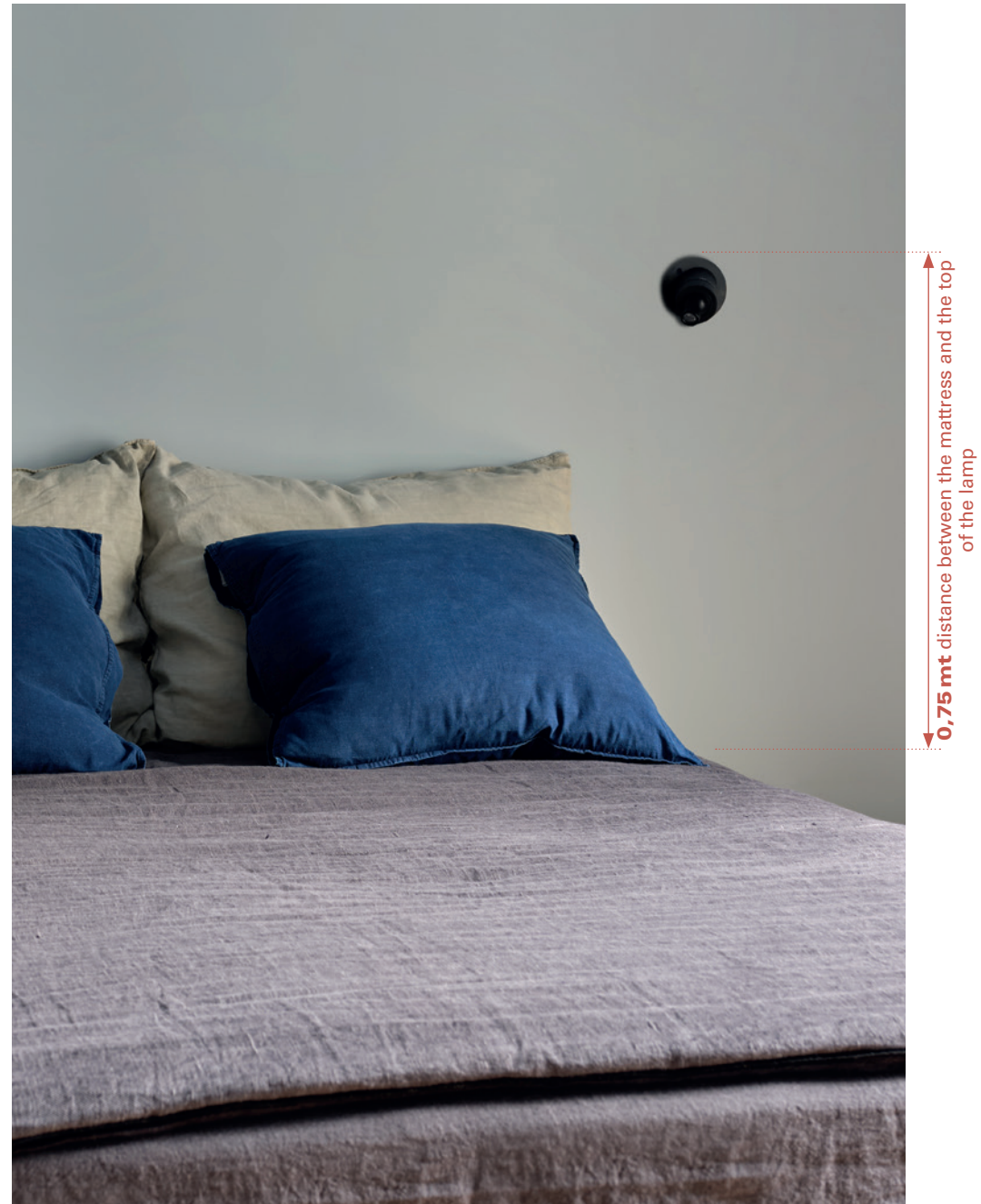

0,75 mt distance between the mattress and the top of the lamp

COVER PLATE for VISION 20/20 SW

IN RENOVATION / BEDSIDE LAMPS

CABLE SET COLLECTION VISION 20/20

If the lamp cannot be hard wired, use the « **CABLE SET** »

**CABLE SET
VISION 20/20**



**CABLE SET VISION 20/20
COMPOSITION**



**CABLE SET
VISION 20/20 SW**



**CABLE SET VISION 20/20 SW
COMPOSITION**

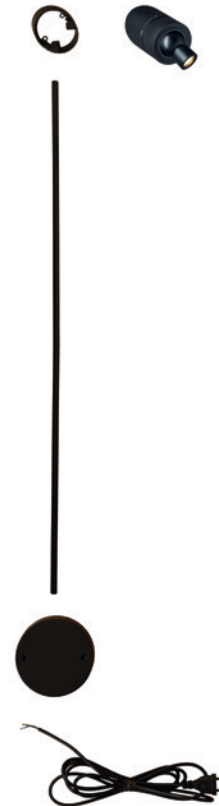

**CABLE SET
VISION 20/20 OMNI &
VISION 20/20 OMNI SW**



**CABLE SET VISION 20/20 OMNI
& VISION 20/20 OMNI SW
COMPOSITION**

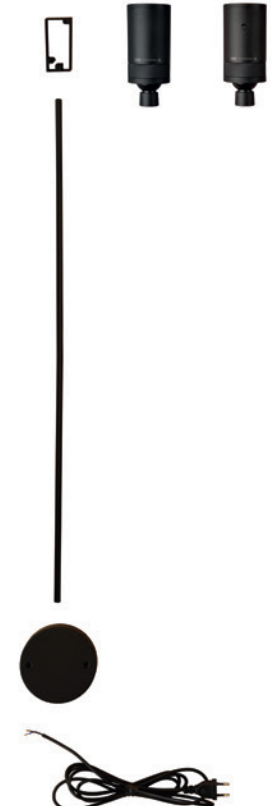

ACCESSORIES

CABLE SET VISION 20/20

CABLE SET VISION 20/20

TECHNICAL SHEET

Accessory	accessory for VISION 20/20
Use	If the lamp cannot be hard wired, use the CABLE SET.
Dimensions (mm)	length : 2000, width : 10
Materials	aluminium, steel
Finish	black

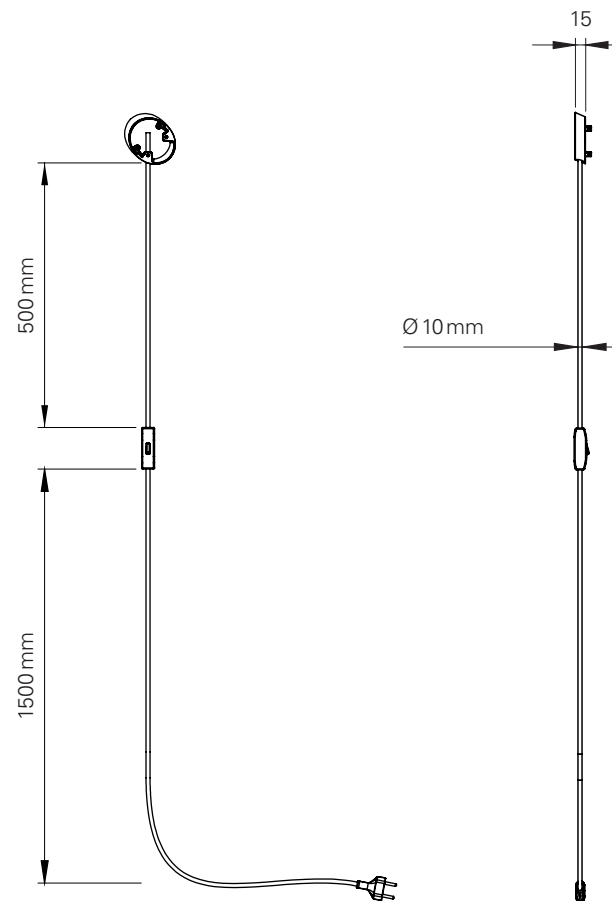

CABLE SET VISION 20/20 SW

CABLE SET VISION 20/20 SW

TECHNICAL SHEET

Accessory	accessory for VISION 20/20 SW
Use	If the lamp cannot be hard wired, use the CABLE SET.
Dimensions (mm)	height: 1383, width: 33
Materials	aluminium, steel
Finish	black

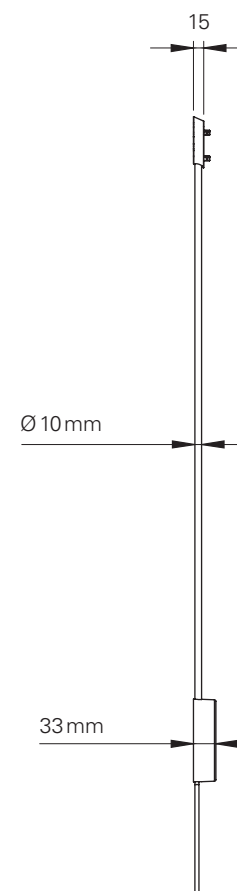
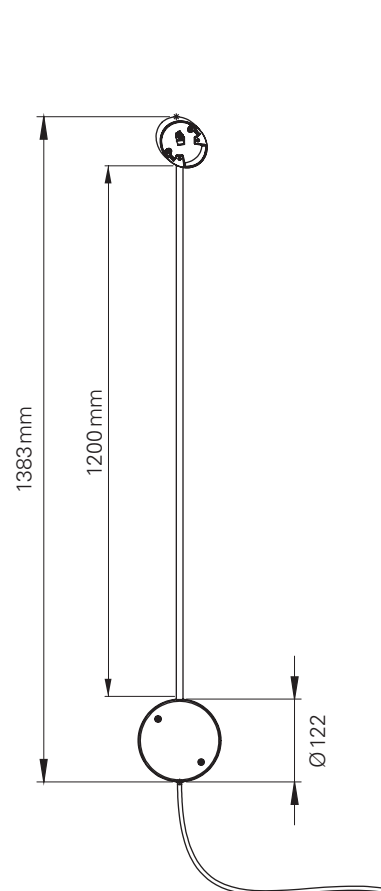

CABLE SET VISION 20/20 OMNI VISION 20/20 OMNI SW

CABLE SET VISION 20/20 OMNI & VISION 20/20 OMNI SW

TECHNICAL SHEET

Accessory	accessory for VISION 20/20 OMNI & OMNI SW
Use	If the lamp cannot be hard wired, use the CABLE SET. This requires a separate switch for the UP LIGHT on the VISION 20/20 OMNI.
Dimensions (mm)	height: 1399, width: 33
Materials	aluminium, steel
Finish	black

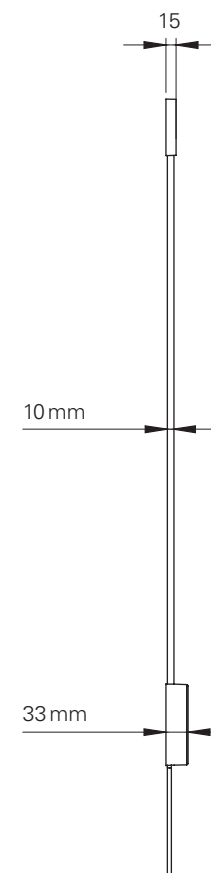
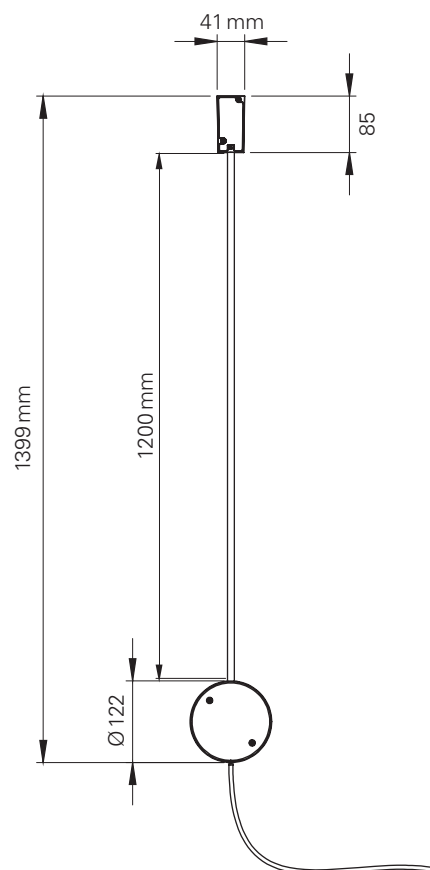

1 mt distance between the mattress and the top of the lamp



CABLE SET for VISION 20/20 OMNI SW

1 mt distance between the mattress and the top of the lamp



CABLE SET for VISION 20/20 OMNI, UP LIGHT activated by a wall switch

0,75 mt distance between the mattress and the top of the lamp



CABLE SET for VISION 20/20 SW

0,75 mt distance between the mattress and the top of the lamp

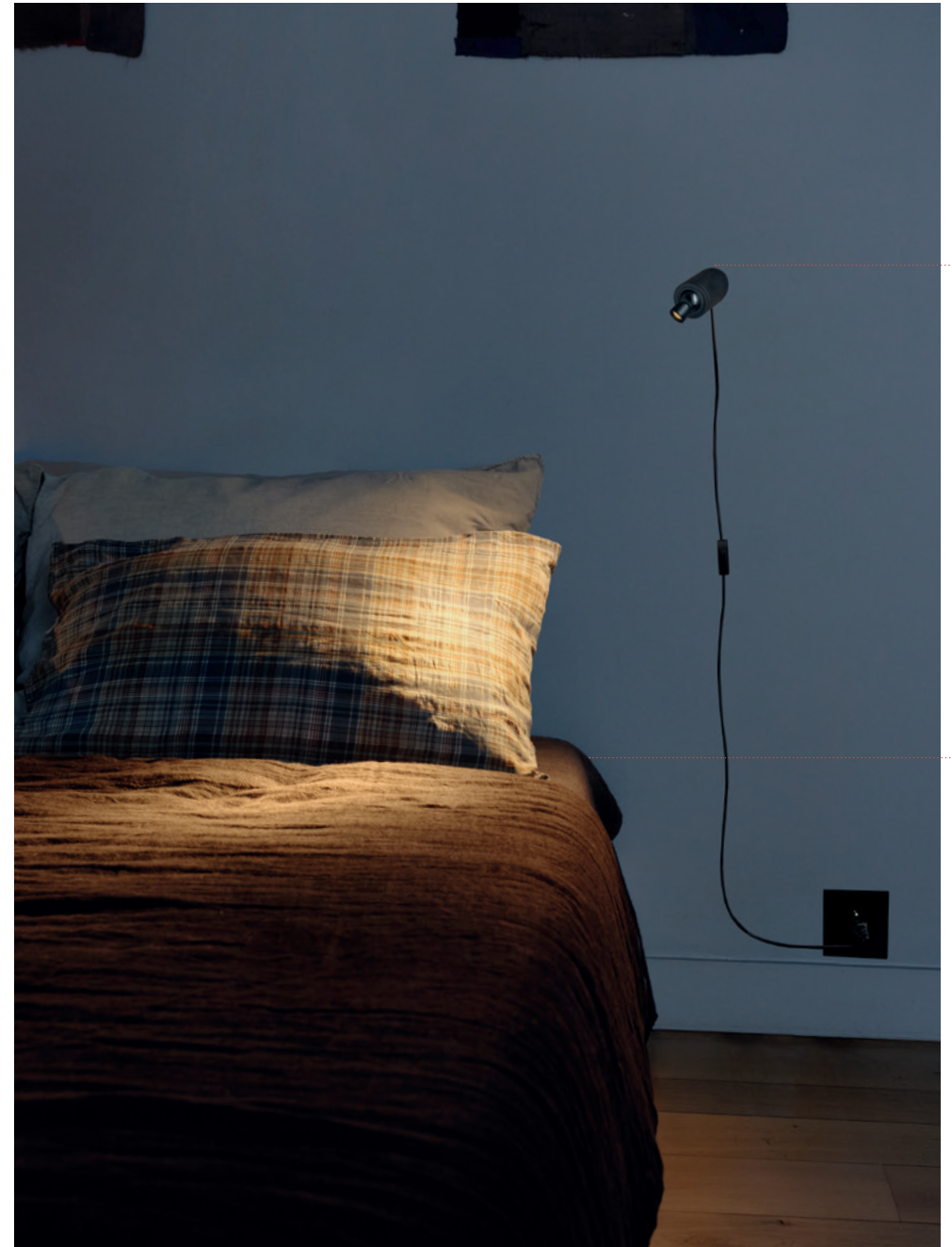

CABLE SET for VISION 20/20, activated by a switch on cable

5	D C W E D I T I O N S	1.0
5,55	D L V A T B K U E H S N	0.9
6,25	R C Y H O F M E S P A	0.8
7,14	E X A T Z H D W N	0.7
8,33	V I S I O N	0.6
10	2 0 / 2 0	0.5
12,50	N L T A V R	0.4