

Magis — "Me too, yo también, moi aussi, ich auch, anch'io..."

TOO ME TOO!

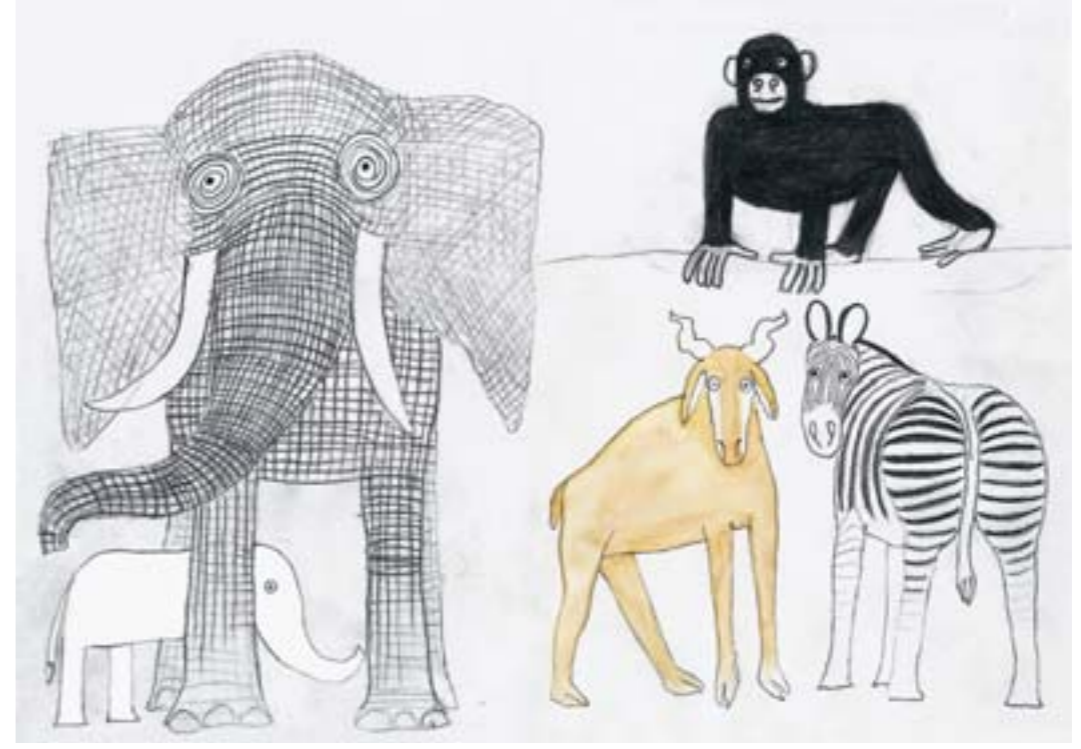

Magis — Me too



designers

Me Too was established to create a world made for children. It is the fruit of our encounter with designers from around the world who can still think, look at things and dream like children, together with Magis.

Me Too nace del deseo de crear un mundo a la medida de los niños y del encuentro con diseñadores de todo el mundo, que todavía saben pensar, mirar y soñar como niños: junto a Magis.

Me Too est issu de deux choses : le désir de créer un monde à la mesure des enfants et la rencontre avec des designers du monde entier qui savent encore penser, regarder et rêver comme les enfants : avec Magis.

Me Too entstand aus dem Wunsch, eine auf Kinder zugeschnittene Welt zu schaffen und aus der Begegnung mit Designern aus aller Welt, die noch wie Kinder denken, schauen und träumen können: gemeinsam mit Magis.

Me Too nasce dal desiderio di creare un mondo a misura di bambino e dall'incontro con designer di tutto il mondo, che sanno ancora pensare, guardare, sognare come i bambini: insieme a Magis.



Eero Aarnio

Flying Carpet 22/23
Pingy 24/26/27
Puppy 28/29/43
Trioli 42



Rea Aarnio-Gibson

Sunny Day 34/35



Björn Dahlström

My House
My Space



El Ultimo Grito

Mico 36/37
Summer to Spring 30/31



Stefano Giovannoni

Tuttifrutti 79



Martí Guixé

Football Tape 56/57
My First Office 48/49
My Zoo 20/21



Giulio Iacchetti

Eur 43



Enzo Mari

Seggiolina Pop 07/46/47



Javier Mariscal

Alma 40/41
El Baúl 08/09
Julian 44/45
Ladrillos 45
Linus 40
Nido 50/51
Piedras 38/39
Reiet 14
Villa Julia 52/53



Benedetta Mori Ubaldini

Birds 10/17
Clouds 11



Marc Newson

Bunky Rocky 12/13
06



Satyendra Pakhalé

Puzzle Carpet 11/46



Philippe Starck

Le Chien Savant 18/19



Oiva Toikka

Dodo 32/34
Downtown 15
Moments of Ingenuity 16/43
Paradise Tree 33



Marcel Wanders

Little Flare 46

index



alma^{40/41} birds^{10/17} bunky^{12/13} clouds¹¹
 dodo^{32/34} downtown¹⁵ el baúl^{08/09}
 eur⁴³ football tape^{56/57} flying carpet^{22/23}
 julian^{44/45} ladrillos⁴⁵ linus⁴⁰
 little flare⁴⁶ le chien savant^{18/19}
 mico^{36/37} moments of ingenuity^{16/43}
 my first office^{48/49} my house⁵⁵
 my space⁵⁴ my zoo^{20/21} nido^{50/51}
 paradise tree³³ piedras^{38/39} pingy^{24/26/27}
 puppy^{28/29/43} puzzle carpet^{11/46}
 reiet¹⁴ rocky⁰⁶ seggiolina pop^{07/46/47}
 summer to spring^{30/31} sunny day^{34/35}
 trioli⁴² tuttifrutti⁷⁹ villa julia^{52/53}
 technical info^{60→86}

Two ways of sitting without ever being still. Rocky, the unbeatable, indestructible rocking horse. Pop, the light seat that can take anything.

Dos maneras de sentarse sin estarse nunca quietos. Rocky, el invencible e indestructible caballito balancín. Pop, la sillita ligera pero resistente a todo.

Deux façons de s'asseoir sans jamais rester immobiles. Rocky, le cheval à bascule invincible et indestructible. Pop, la petite chaise légère qui résiste à tout.

Zwei Arten zu sitzen, aber immer in Bewegung bleiben. Rocky, das unbesiegbar, unzerstörbare Schaukelpferd. Pop, ein leichter Kinderstuhl, der aber alles aushalten kann.

Due modi di sedersi senza stare mai fermi. Rocky, l'invincibile e indistruttibile cavallo a dondolo. Pop, la seggiolina leggera ma resistente a tutto.



rocky

by Marc Newson
→63

seggolina
pop

by Enzo Mari
→67

El Baúl, the chest for your treasure. A friend that always has room for favourite toys, costumes for dressing up or secrets to be hidden before the pirates get ready to board.

el baúl

by Javier Mariscal
→65



Quien tiene El Baúl tiene un tesoro. Un amigo en el que caben todos los juegos preferidos, los vestidos para disfrazarse, los secretos que hay que esconder, antes de que lleguen los piratas.

Celui qui trouve El Baúl trouve un trésor. Un ami qui fait de la place à tous tes jouets préférés, à tes déguisements et aux secrets à cacher avant l'arrivée des pirates.

Wer El Baúl findet, findet einen Schatz. Ein Freund, in dem das Lieblingsspielzeug Platz findet, Verkleidungen, geheime Schätze, die es vor Piraten zu verstecken gilt.

Chi trova El Baúl trova un tesoro. Un amico che dà spazio a tutti i giochi preferiti, i vestiti per travestirsi, i segreti da nascondere, prima che arrivino i pirati.





birds

by Benedetta Mori Ubaldini
→61

Birds and Clouds dangle on a thread, they play with the air and light, telling stories that are always different, like the Puzzle Carpet.

Birds y Clouds se balancean colgando de un hilo, juegan con el aire y la luz, cuentan historias distintas cada vez, como la alfombra Puzzle Carpet.

Birds et Clouds se balancent, pendus à un fil ; ils jouent avec l'air et la lumière, ils racontent des histoires toujours différentes, tout comme le tapis Puzzle Carpet.

Birds und Clouds sind auf einer Schnur aufgehängt und schaukeln in Luft und Licht, erzählen immer neue Geschichten wie der Teppich Puzzle Carpet.

Birds e Clouds dondolano appesi a un filo, giocano con l'aria e la luce, raccontano storie sempre diverse, come il tappeto Puzzle Carpet.



clouds

by Benedetta Mori Ubaldini
→61

puzzle carpet

by Satyendra Pakhalé
→85

bunky

by Marc Newson
→73



Bunky es una torre de colores que se puede construir al gusto de cada uno en la que dormir, jugar, leer, escalar. Y hacer todo lo que se quiera.

Bunky est une tour colorée que tu peux construire à ton gré et dans laquelle tu peux dormir, jouer, lire, grimper et faire tout ce que tu veux.

Bunky ist ein bunter Turm, den man beliebig bauen kann, wo man schlafen, spielen, lesen und auf den man klettern kann, ganz wie man will.

Bunky è una torre colorata che si può costruire a piacimento, dove dormire, giocare, leggere, arrampicarsi, fare tutto quello si vuole.

***Bunky is a colourful tower
to build as you like,
where you can sleep, play,
read, climb or do anything
you like.***

*It's never too soon to be a star.
Feel like a king or queen
on their throne, with Reiet.
Use a skyscraper as a bookcase,
with Downtown.*

Nunca es demasiado pronto para ser protagonista. Sentirse como un rey o una reina en el trono, con Reiet, o usar un rascacielos como estantería, con Downtown.

Il n'est jamais trop tôt pour être un héros. Se sentir comme un roi ou une reine sur un trône, avec Reiet. Utiliser un gratte-ciel comme bibliothèque, avec Downtown.

Es ist nie zu früh, ein Star zu sein. Sich wie ein König oder eine Königin auf dem Thron zu fühlen, mit Reiet. Einen Wolkenkratzer als Bücherregal zu nutzen, mit Downtown.

Non è mai troppo presto per essere protagonisti. Sentirsi come un re o una regina su un trono, con Reiet. Usare un grattacielo come libreria, con Downtown.



reiet

by Javier Mariscal
→67



downtown

by Oiva Toikka
→81





moments of ingenuity

by Oiva Toikka
→86

birds

by Benedetta Mori Ubaldini
→61



Le Chien Savant has taken it into his head to make all children as clever as he is. What a shame there's not a dog like him for grown-ups, too.

Le Chien Savant se le ha metido en la cabeza hacer que todos los niños se conviertan en sabios como él. Qué lástima que no haya un perro así para los mayores.

Le Chien Savant s'est mis en tête de faire de tous les enfants des savants à son image. Quel dommage qu'il n'y ait pas un chien comme ça pour les grands !

Le Chien Savant hat es sich in den Kopf gesetzt, alle Kinder so gelehrt zu machen, wie er es ist. Wie schade, dass es einen solchen Hund nicht auch für die Grossen gibt!

Le Chien Savant si è messo in testa di fare diventare sapienti come lui tutti i bambini. Che peccato che non c'è un cane così anche per i grandi.



le chien savant

by Philippe Starck
according to an idea of C.Bavaud
→70





*The animals of My Zoo
are fun to build like giant toys
and you can colour them
with all the colours you want.*

my zoo

by Martí Guixé
→60

Los animales de My Zoo se construyen como juguetes gigantes y se pueden pintar con todos los colores que uno quiera. ¡Empieza la diversión!

Les animaux de My Zoo sont amusants à construire comme des jouets gigantesques que tu peux colorier de toutes les couleurs qui te plaisent.

Die Tiere von My Zoo lassen sich zu lustigen Riesenspielzeugen zusammenbauen, die man bunt bemalen kann.

Gli animali di My Zoo sono divertenti da costruire come giocattoli giganti e liberi da colorare con tutti i colori che si vuole.

*After each flight,
Flying Carpet can be parked
in the house,
or outdoors on its rocker base.*

Tras cada vuelo, Flying Carpet se puede aparcar tranquilamente en casa o en el exterior, sobre su plataforma oscilante.

Après chaque vol, tu peux tranquillement garer Flying Carpet dans la maison ou dehors, sur sa plate-forme oscillante.

Nach jedem Flug kann Flying Carpet unbesorgt daheim oder im Freien auf seiner schwankenden Plattform geparkt werden.

Dopo ogni volo, Flying Carpet si può tranquillamente parcheggiare in casa oppure anche all'aperto, sulla sua piattaforma oscillante.

flying carpet

by Eero Aarnio
→71



pingy
by Eero Aarnio
→65

***Animals always play a special role
in the life of a child.
Perhaps Pingy has eaten too
much, that's why he's so funny as
he rocks on his tummy.***



pingy

by Eero Aarnio
→65

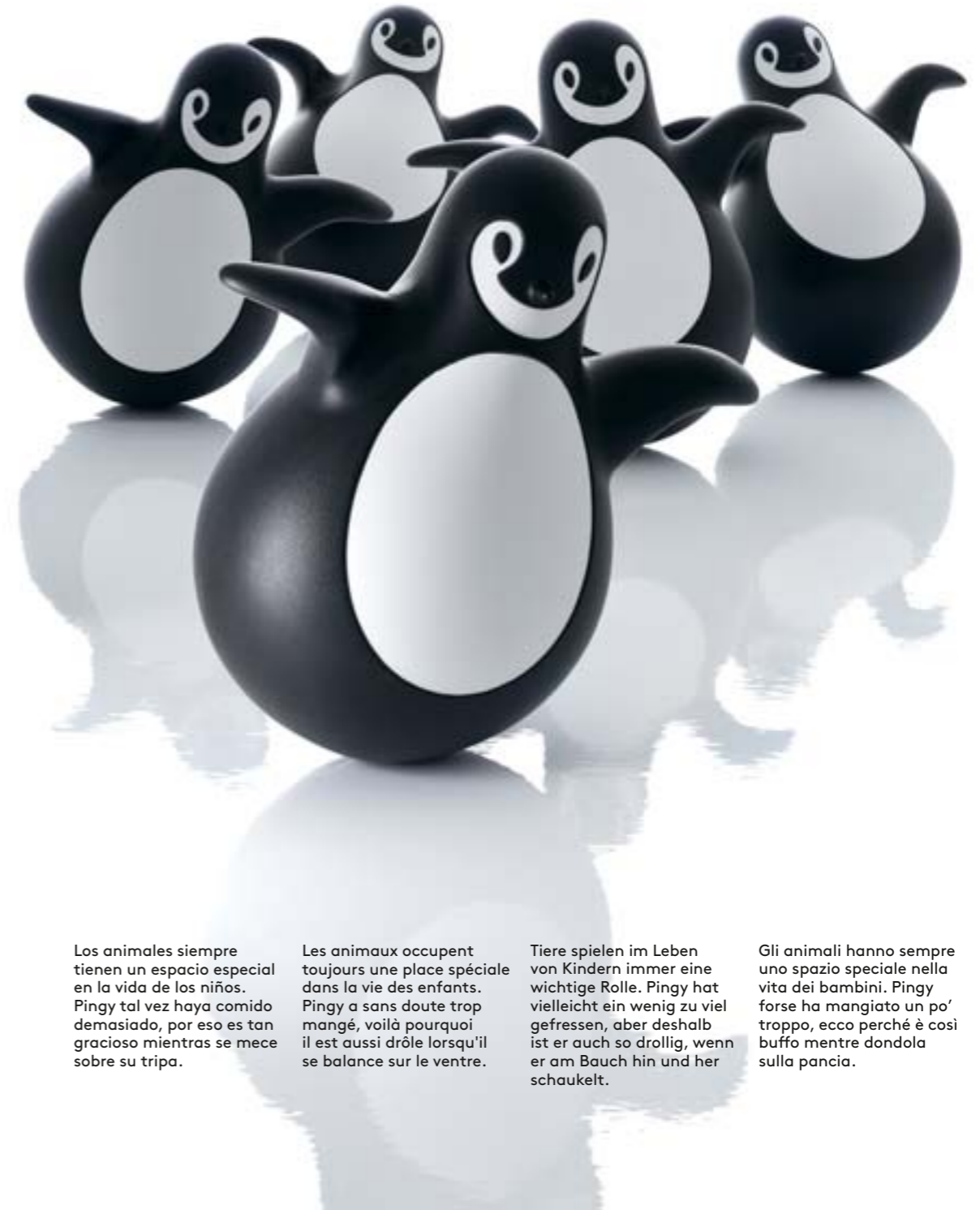

Los animales siempre tienen un espacio especial en la vida de los niños. Pingy tal vez haya comido demasiado, por eso es tan gracioso mientras se mece sobre su tripa.

Les animaux occupent toujours une place spéciale dans la vie des enfants. Pingy a sans doute trop mangé, voilà pourquoi il est aussi drôle lorsqu'il se balance sur le ventre.

Tiere spielen im Leben von Kindern immer eine wichtige Rolle. Pingy hat vielleicht ein wenig zu viel gefressen, aber deshalb ist er auch so drollig, wenn er am Bauch hin und her schaukelt.

Gli animali hanno sempre uno spazio speciale nella vita dei bambini. Pingy forse ha mangiato un po' troppo, ecco perché è così buffo mentre dondola sulla pancia.

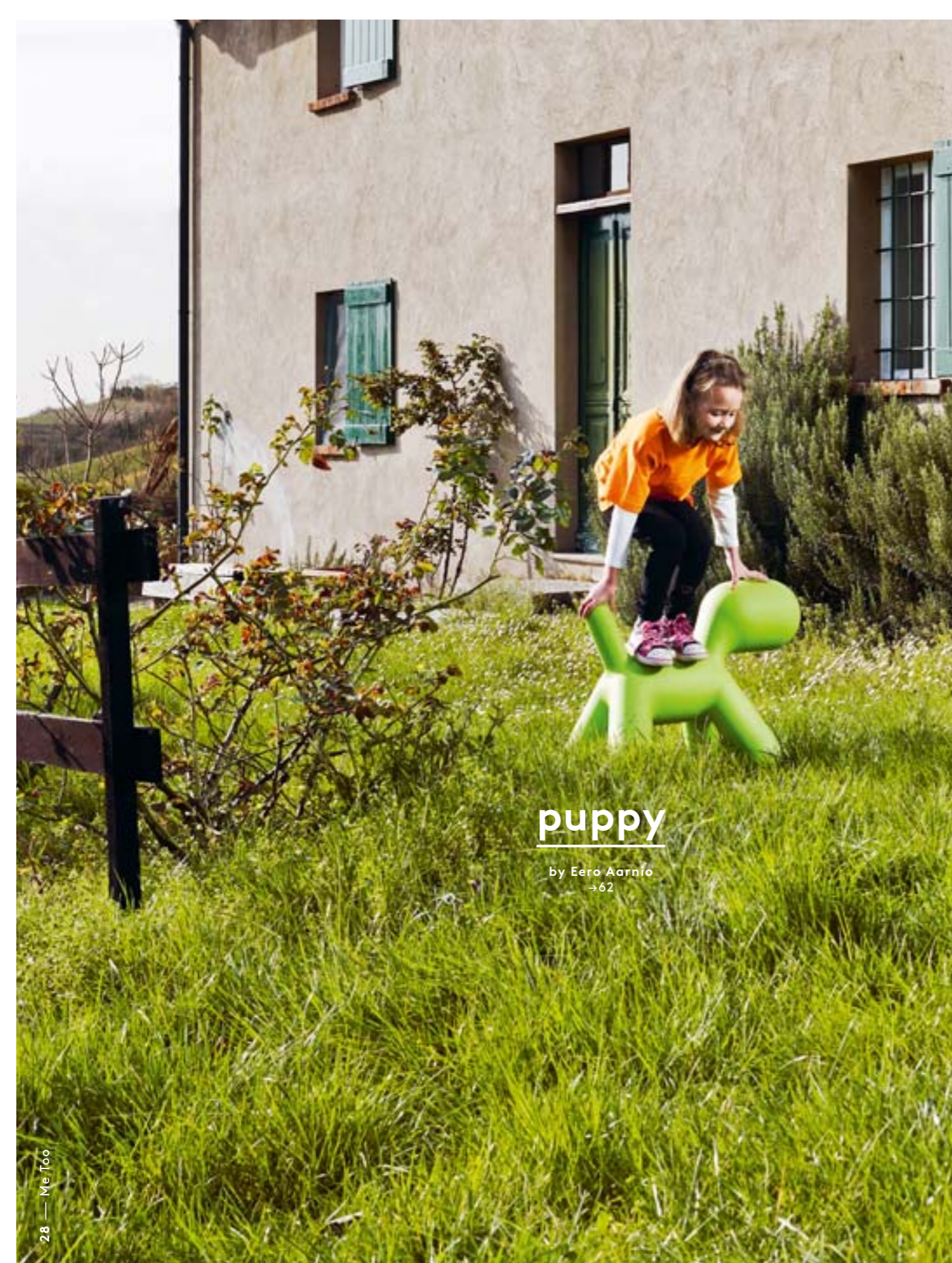

puppy

by Eero Aarnio
→ 62

*Puppy isn't just any dog.
He's as a child imagines a dog when
drawing one for the first time:
head, body, paws. That's why he's so
fantastic, including his colours.*



Puppy no es un perro cualquiera, sino un cachorro imaginado por un niño cuando lo dibuja por primera vez: cabeza, cuerpo, patas. Por eso es tan fantástico, incluso en los colores.

Puppy n'est pas un chien comme les autres, mais un chiot imaginé par un enfant, quand il le dessine pour la première fois : tête, corps, pattes. C'est pour ça qu'il est génial : même au niveau des couleurs.

Puppy ist nicht irgendein Hund, Puppy ist ein Hundebaby, so wie es ein Kind zum ersten Mal zeichnen würde: Kopf, Körper, Pfoten. Deshalb ist es auch so fantasievoll: auch in den Farben.

Puppy non è un cane qualsiasi, ma un cucciolo immaginato da un bambino, quando lo disegna la prima volta: testa, corpo, zampe. Ecco perché è così fantastico: anche nei colori.



single

piggy
bank

micelin

times table

dress

numbers

two

trousers

skirt

summer to spring

by El Último Grito
→74



**Dodo is the mythical rocking bird
that finds its natural habitat
in the home or the garden.
Paradise Tree is a coat stand where
a cat, a bird and a load of clothes
live happily together.**

Dodo es un exótico pájaro balancín que encuentra su hábitat natural en casa o en el jardín. Paradise Tree es la percha en la que conviven felices un gato, un pájaro y toda la ropa.

Dodo est le célèbre oiseau à bascule qui trouve son habitat naturel à la maison ou dans le jardin. Paradise Tree est le portemanteau sur lequel cohabitent en harmonie un chat, un oiseau et tous tes vêtements.

Dodo ist eine Vogelschaukel, die daheim und im Garten in ihrem Element ist. Paradise Tree ist ein Kleiderständer, auf dem eine Katze, ein kleiner Vogel und alle Kleider friedlich miteinander leben.

Dodo è il mitico uccello a dondolo che trova un habitat naturale in casa o in giardino. Paradise Tree è l'appendiabiti sul quale convivono felici un gatto, un uccellino e tutti i vestiti.

dodo

by Oiva Toikka
→63



paradise tree

by Oiva Toikka
→75

dodo

by Oiva Toikka
→63

sunny day

by Rea Aarnio-Gibson
→72



***What's Mico? Quite simply
anything you want.
A table, a chair, a toy or
a definitely non-imaginary friend
who's colourful and strong.***

Pero, ¿qué es Mico? Muy fácil, Mico es todo lo que tú quieras. Una mesa, una silla, un juguete, o bien un amigo nada imaginario; más bien con mucho color y muy resistente.

Mais c'est quoi Mico ? C'est simple, c'est tout ce que tu veux : une table basse, une chaise, un jeu ou un ami nullement imaginaire mais plutôt coloré et très résistant.

Aber was ist Mico? Ganz einfach, alles was du willst. Ein kleiner Tisch, ein Stuhl, ein Spiel, ein gar nicht imaginärer Freund, er ist bunt und hält alles aus.

Ma che cos'è Mico? Semplice, tutto quello che vuoi tu. Un tavolino, una sedia, un gioco, oppure un amico per nulla immaginario, anzi colorato e molto resistente.



mico

by El Ultimo Grito
→70

Piedras, es decir un sofá, un sillón y una mesa casi iguales a los de los hombres primitivos, pero mucho más ligeros y cómodos.

Piedras : un divan, un fauteuil et une table basse presque identiques à ceux des hommes primitifs, mais beaucoup plus légers et confortables.

Piedras, oder ein Sofa, ein Lehnstuhl und ein kleiner Tisch, die aus der Steinzeit stammen könnten, nur dass sie viel leichter und bequemer sind.

Piedras, ovvero un divano, una poltrona e un tavolino quasi uguali a quelli degli uomini primitivi, ma molto più leggeri e comodi.



pedras

by Javier Mariscal
→66

*Piedras, in other words
a sofa, an armchair
and a low table almost like
those of primitive Man,
but lighter and comfier.*



*Around a Linus table,
the Alma backrest's technical
reinforcements become a game:
find the little birds hiding
in the trees.*

En torno a la mesa Linus, los refuerzos técnicos del respaldo de Alma se convierten en un juego: encontrar los pájaros en medio de los árboles.

Autour de la table Linus, les renforts techniques du dossier d'Alma se transforment en un jeu : trouver les petits oiseaux parmi les arbres.

Rund um Tisch Linus, werden die technischen Verstärkungen der Rückenlehne von Alma zum Spiel: die kleinen Vögel inmitten der Bäume zu finden.

Intorno al tavolo Linus, i rinforzi tecnici dello schienale di Alma diventano un gioco: trovare gli uccellini in mezzo agli alberi.



alma+linus

by Javier Mariscal
→68





seggolina pop

by Enzo Mari
→67



trioli

by Eero Aarnio
→64

**moments of
ingenuity**

by Oiva Toikka
→86

puppy

by Eero Aarnio
→62



eur

by Giulio Iacchetti
→78





Julian has seven lives: he's a cat, a chair, a toy... you invent the other four, together with lots of stories about the characters of the Ladrillos bookcase.

Julián tiene siete vidas:
es un gato, una silla, un
juguete... las otras cuatro
invéntalas tú, junto
a tantas otras historias
con los personajes
de la estantería Ladrillos.

Julian a sept vies :
c'est un chat, une chaise,
un jouet... les quatre
autres, inventes-les toi,
ainsi que de nombreuses
autres histoires, avec
les personnages de
la bibliothèque Ladrillos.

Julian hat sieben Leben:
Julian ist eine Katze,
ein Stuhl, ein Spielzeug...
die anderen vier kannst du
selbst erfinden, gemeinsam
mit vielen weiteren
Geschichten mit den
Helden des Bücherregals
Ladrillos.

Julian ha sette vite:
è un gatto, una sedia, un
giocattolo... le altre quattro
inventale tu, insieme
a tante altre storie con
i personaggi della libreria
Ladrillos.

julian

by Javier Mariscal
→64



puzzle carpet

by Satyendra Pakhalé
→85

little flare

by Marcel Wanders
→69

seggiolina pop

by Enzo Mari
→67



Señorita, escriba. Quiero una oficina, una biblioteca, un castillo, una estación espacial, una habitación toda para mí. Firmado: My First Office.

Mademoiselle, écrivez. Je veux un bureau, une bibliothèque, un château, une station spatiale, une pièce rien qu'à moi. Signé : My First Office.

Mein Fräulein, schreiben Sie! Ich will ein Büro, eine Bibliothek, ein Schloss, eine Raumstation, ein Zimmer ganz für mich allein. Unterschrift: My First Office.

Signorina, scriva. Voglio un ufficio, una biblioteca, un castello, una stazione spaziale, una stanza tutta per me. Firmato: My First Office.



my first office

by Martí Guixé
→84

**Take a note: I want an office,
a library, a castle, a space
station and a room of my own.
Signed: My First Office.**



*Nido is a friendly monster,
a protective shell,
a den to shelter in and stretch
out on your tummy,
like lying on the grass.*



Nido es un monstruo bueno, un caparazón protector, una guarida en la que refugiarse y estar estirados boca abajo, como sobre la hierba.

Nido est un monstre gentil, une carapace de protection, une tanière dans laquelle se réfugier et rester allongé sur le dos, comme dans l'herbe.

Nido ist ein gutmütiges Ungetüm, eine schützende Schale, eine Höhle, in der man sich verkriechen und am Bauch liegen kann, wie auf einer Wiese.

Nido è un mostro buono, un guscio protettivo, una tana in cui rifugiarsi e stare distesi a pancia in giù, come sull'erba.



nido

by Javier Mariscal
→ 82



villa julia

by Javier Mariscal
→ 83

*No entry to non-children.
Villa Julia is a house
to be assembled and lived in.
My Space is an illustrated screen.
My House is a tablecloth
for playing hideaway.*



my space

by Björn Dahlström
→76

my house

by Björn Dahlström
→77



Prohibida la entrada a los mayores. Villa Julia es una casa para montar y vivir en ella. My Space es un biombo ilustrado. My House es una tela para jugar a esconderse.

Entrée interdite aux non-enfants. Villa Julia est une maison à construire et à habiter. My Space est un paravent illustré. My House est une nappe pour jouer à cache-cache.

Zutritt für Erwachsene verboten. Villa Julia ist ein Haus, das man aufbauen und bewohnen kann. My Space ist eine illustrierte Trennwand. My House ist ein Tischtuch, wo man verstecken spielen kann.

Vietato l'ingresso ai non bambini. Villa Julia è una casa da montare ed abitare. My Space è un divisorio illustrato. My House è una tovaglia per giocare a nascondersi.

**Football Tape turns an ordinary
scrunched-up newspaper
into a football: straight into
the net!**



football tape

by Martí Guixé
→85

Football Tape transforma
un sencillo periódico
arrugado en un balón de
fútbol: y es en seguida gol.

Football Tape transforme
un simple journal roulé en
boule en un ballon de foot :
but !

Football Tape verwandelt
eine zerknüllte Zeitung
in einen Fussball: und sofort
ein Tor!

Football Tape trasforma
un semplice giornale
appallottolato in un pallone
da calcio: ed è subito goal.



technical info



alma⁶⁸ birds⁶¹ bunky⁷³ clouds⁶¹
 dodo⁶³ downtown⁸¹ el baúl⁶⁵
 eur⁷⁸ football tape⁸⁵ flying carpet⁷¹
 julian⁶⁴ ladrillos⁸⁰ linus⁶⁸
 little flare⁶⁹ le chien savant⁷⁰
 mico⁷⁰ moments of ingenuity⁸⁶
 my first office⁸⁴ my house⁷⁷
 my space⁷⁶ my zoo⁶⁰ nido⁸²
 paradise tree⁷⁵ piedras⁶⁶ pingy⁶⁵
 puppy⁶² puzzle carpet⁸⁵
 reiet⁶⁷ rocky⁶³ seggiolina pop⁶⁷
 summer to spring⁷⁴ sunny day⁷² trioli⁶⁴
 tuttifrutti⁷⁹ villa julia⁸³

My Zoo — design Martí Guixé, 2012

Animal figures
Material: cardboard.

Figuras de animales
Material: cartón.

Figures d'animaux
Matériaux: carton.

Tierfiguren
Material: Karton.

Figure di animali
Materiale: cartone.

→ 20/21

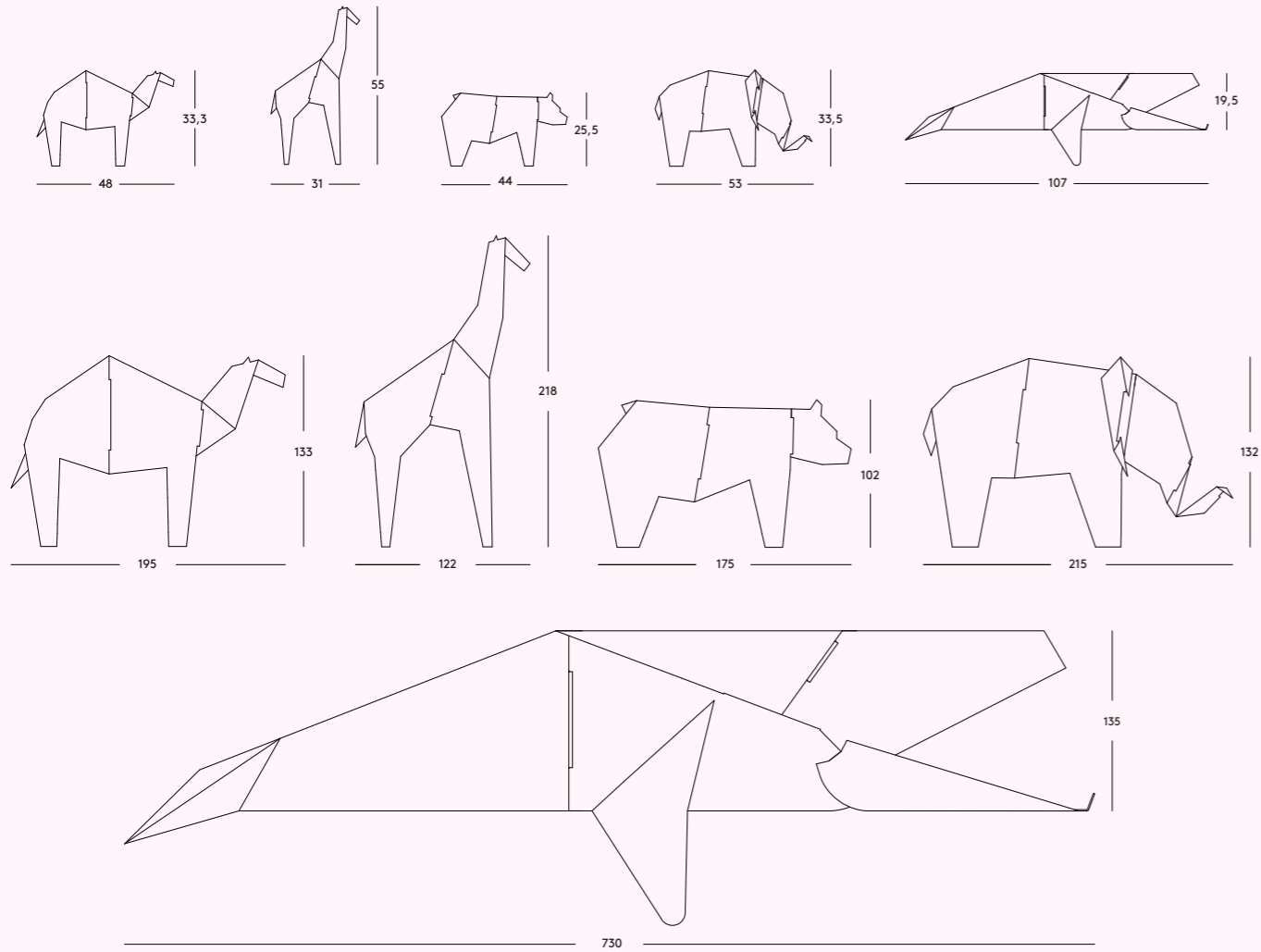

Birds + Clouds — design Benedetta Mori Ubaldini, 2012

Birds + Clouds
Material: metal mesh painted in epoxy resin.
Supplied with hook for ceiling fixing.

→ 10/17 + 11

Aves + Nubes
Material: malla de alambre barnizada con pintura epoxi. Completas con gancho para fijar al techo.

Oiseaux + Nuages
Matériaux: haie métallique vernie en résine époxy. Fournies de crochet pour la fixation au plafond.

Vögel + Wolken
Material: Maschendraht, epoxylackiert. Komplet mit Befestigungshaken zur Deckenmontage.

Uccelli + Nuvole
Materiale: rete metallica verniciata in resina epossidica. Completa di gancio di fissaggio a soffitto.

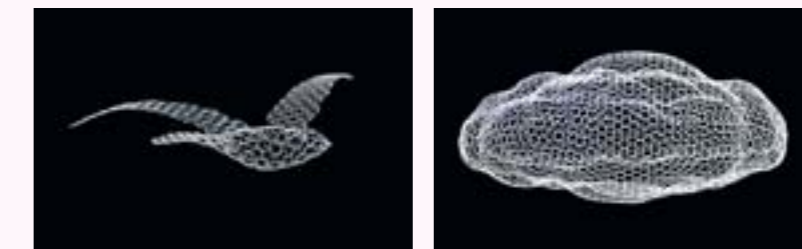
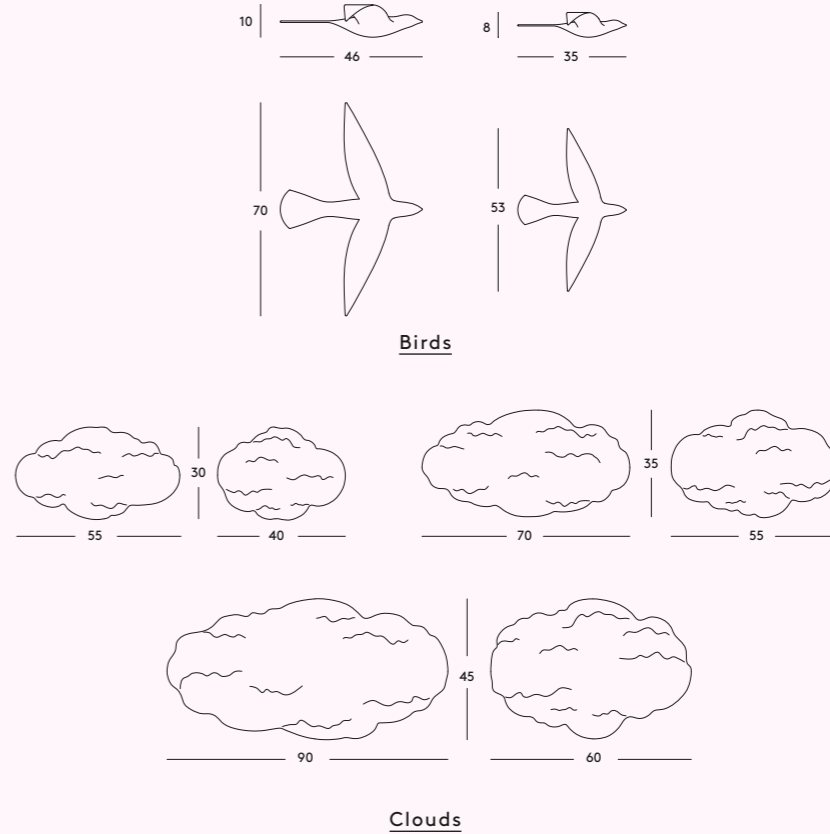

Matt colour
Grey 5069

Matt colour
White 5110

Puppy — design Eero Aarnio, 2005

Abstract plastic dog
Material: rotational-moulded polyethylene.
Suitable for outdoor use.

Perro abstracto
Material: polietileno por moldeo rotacional.
Apto para el exterior

Chien abstrait
Matériaux: polyéthylène moulé par rotation.
Conçu pour l'extérieur.

Abstrakter Hund
Material: Polyäthylen.
Hergestellt im Rotationsverfahren. Auch für den Aussenbereich geeignet.

Cane astratto
Materiale: polietilene stampato in rotational moulding. Adatto anche per esterni.

→ 28/29/43

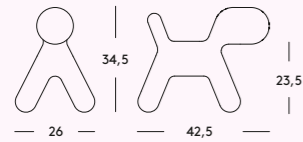

Small

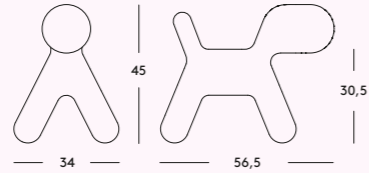

Medium

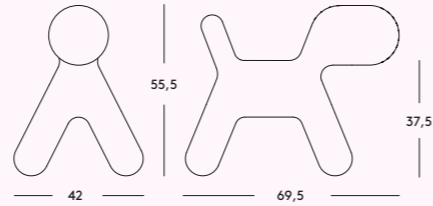

Large

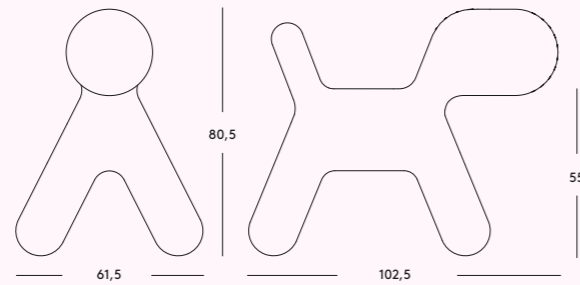

Extra large



Matt colour
Orange 1001 C



Matt colour
Green 1360 C



Matt colour
White 1700 C



Matt colour
Dalmatian

Rocky — design Marc Newson, 2012

Rocking horse
Material: rotational-moulded polyethylene.
Rein in natural hemp rope.

Caballo balancín
Material: polietileno por moldeo rotacional. Rienda de cáñamo natural.

Cheval à bascule
Matériaux: polyéthylène moulé par rotation. Rêne en corde de chanvre naturel.

Schaukelpferd
Material: Polyäthylen, hergestellt im Rotationsverfahren. Zügel aus Natur-Hanf.

Cavallo a dondolo
Materiale: polietilene stampato in rotational moulding. Redine in corda di canapa naturale.

→ 06

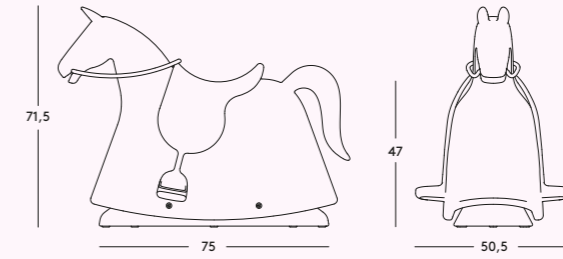

Matt colour
Brown 1069 C



Matt colour
White 1736 C



Matt colour
Black 1768 C

Dodo — design Oiva Toikka, 2009

Rocking bird
Material: rotational-moulded polyethylene.
Suitable for outdoor use.

Ave mecedora
Material: polietileno por moldeo rotacional. Apto para el exterior.

Oiseau à bascule
Matériaux: polyéthylène moulé par rotation. Conçu pour l'extérieur.

Schaukelvogel
Material: Polyäthylen. Hergestellt im Rotationsverfahren. Auch für den Aussenbereich geeignet.

Uccello a dondolo
Materiale: polietilene in rotational moulding. Adatto anche per esterni.

→ 32/34

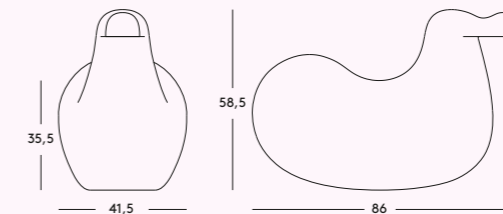

Matt colour
Red 1004 C



Matt colour
Yellow 1025 C



Matt colour
Blue 1252 C



Matt colour
White 1735 C

Trioli — design Eero Aarnio, 2005

Children's chair
Material: rotational-moulded polyethylene. Two different seat heights. It can also be used as a rocker. Suitable for outdoor use.

Silla para niños con tres posibles usos
Material: polietileno por moldeo rotacional. También se puede usar como mecedora. Apta para el exterior.

Chaise pour enfant
Matériaux: polyéthylène moulé par rotation. Deux différentes hauteurs d'assise. La chaise peut être utilisée aussi comme cheval à bascule. Conçue pour l'extérieur.

Kinderstuhl
Material: Polyäthylen. Hergestellt im Rotationsverfahren. Zwei verschiedene Sitzhöhen. Der Stuhl kann auch als Wippe benutzt werden. Auch für den Aussenbereich geeignet.

Sedia per bambini a tre usi: alta, bassa e cavallo a dondolo
Materiale: polietilene stampato in rotational moulding. Adatta anche per esterni.

→ 42

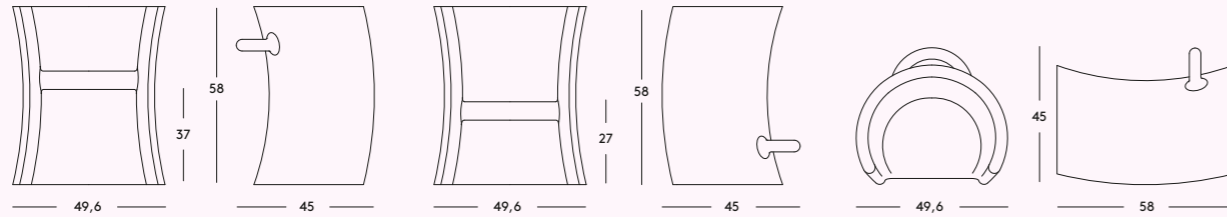

Matt colour Red 1004 C



Matt colour Blue 1252 C



Matt colour Yellow 1665 C



Matt colour White 1700 C

Julian — design Javier Mariscal, 2005

Children's chair
Material: rotational-moulded polyethylene. Suitable for outdoor use.

Silla para niños
Material: polietileno por moldeo rotacional. Apta para el exterior.

Chaise pour enfant
Matériaux: polyéthylène moulé par rotation. Conçue pour l'extérieur.

Kinderstuhl
Material: Polyäthylen. Hergestellt im Rotationsverfahren. Auch für den Aussenbereich geeignet.

Sedia per bambini
Materiale: polietilene stampato in rotational moulding. Adatta anche per esterni.

→ 44/45

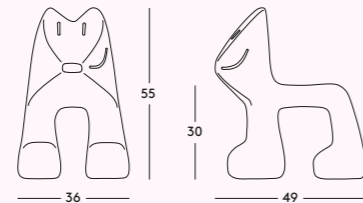

Matt colour Red 1122 C



Matt colour Green 1290 C



Matt colour Yellow 1665 C



Matt colour White 1735 C

Pingy — design Eero Aarnio, 2011

Penguin
Materials: rotational-moulded polyethylene.

→ 24/26/27

Pingüino
Materiales: polietileno por moldeo rotacional.

Pinguin
Matériaux: polyéthylène moulé par rotation.

Pinguin
Materialien: Polyäthylen. Hergestellt im Rotationsverfahren.

Pinguino
Materiale: polietilene stampato in rotational moulding.

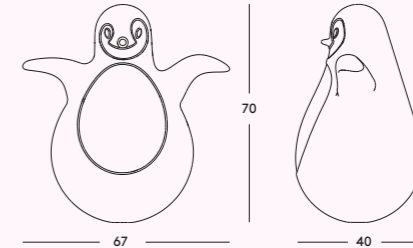

Matt colour Black 1763 C

El Baúl — design Javier Mariscal, 2005

Trunk/container
Material: rotational-moulded polyethylene.

→ 08/09

Baúl/contenedor
Material: polietileno por moldeo rotacional.

Coffre
Matériaux: polyéthylène moulé par rotation.

Box
Material: Polyäthylen. Hergestellt im Rotationsverfahren.

Baule contenitore
Materiale: polietilene stampato in rotational moulding.

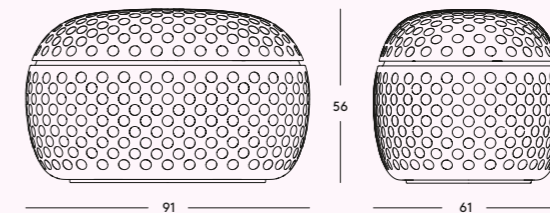

Matt colour White 1700 C

Piedras — design Javier Mariscal, 2006

Low chair, bench and low table
Material: rotational-moulded polyethylene. Suitable for outdoor use.

Sillón, sofá y mesita
Material: polietileno por moldeo rotacional. Aptos para el exterior.

Fauteuil, canapé et petite table
Matériaux: polyéthylène moulé par rotation. Conçus pour l'extérieur.

Niedriger Stuhl, Sofa und niedriger Tisch
Material: Polyäthylen. Hergestellt im Rotationsverfahren. Auch für den Aussenbereich geeignet.

Famiglia di sedute (a 1 e 2 posti) e tavolino di appoggio
Materiale: polietilene stampato in rotational moulding. Adatta anche per esterni.

→ 38/39

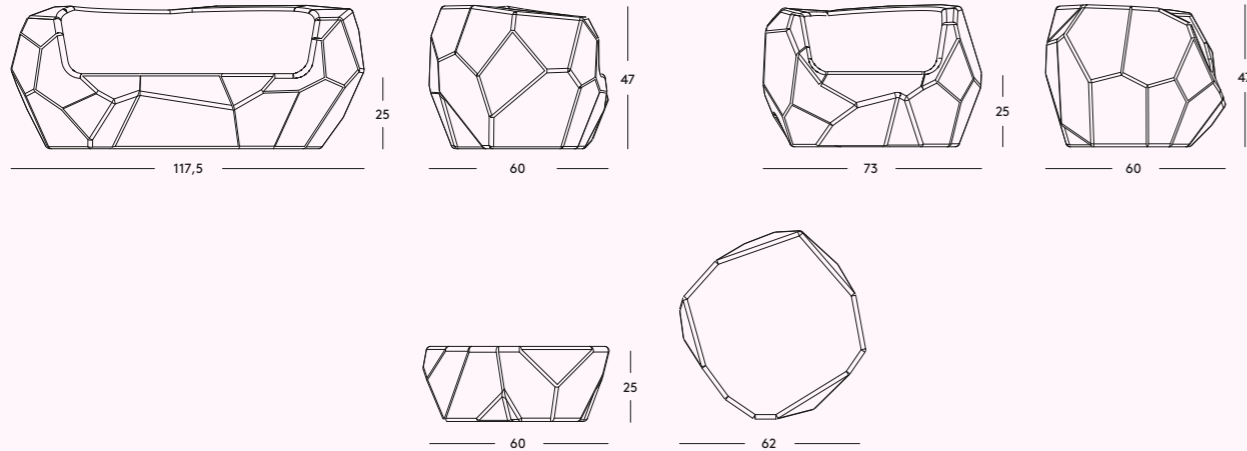

Matt colour
Grey anthracite 1407 C

Seggiolina Pop — design Enzo Mari, 2004

Children's chair
Material: expanded polypropylene.

→ 07/46/47

Silla para niños
Material: polipropileno expandido.

Chaise pour enfant
Matériaux: polypropylène expansé.

Kinderstuhl
Material: geschäumtes Polypropylen.

Sedia per bambini
Materiale: polipropilene espanso.

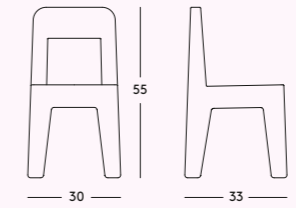

Matt colour
Orange 1082 C



Matt colour
Blue 1606 C



Matt colour
Green 1638 C

Reiet — design Javier Mariscal, 2011

Children's chair
Material: painted solid beech.

→ 14

Silla para niños
Material: madera maciza de haya barnizada.

Chaise pour enfant
Matériaux: hêtre massif teinté.

Kinderstuhl
Materialien: massive Buche, gebeizt.

Sedia per bambini
Materiale: massello di faggio verniciato.

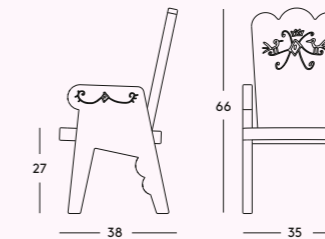

Matt colour
Yellow 7003



Matt colour
Orange 7006



Matt colour
Prussian green 7009

Alma — design Javier Mariscal, 2006

Stacking children's chair
Material: polypropylene with glass fibre added. Standard injection-moulded. Suitable for outdoor use.

Silla para niños apilable
Material: polipropileno reforzado con fibra de vidrio moldeado por inyección estándar. Apta para el exterior.

Chaise pour enfant empilable
Matériaux: polypropylène chargé avec fibre de verre moulé par injection standard. Conçue pour l'extérieur.

Kinderstuhl, stapelbar empilbar
Material: Polypropylen mit Glasfaser verstärkt. Hergestellt im Standard-Einspritzverfahren. Auch für den Aussenbereich geeignet.

Sedia per bambini impilabile
Materiale: polipropilene caricato di fibra di vetro stampato ad iniezione standard. Adatta anche per esterni.

→ 40/41

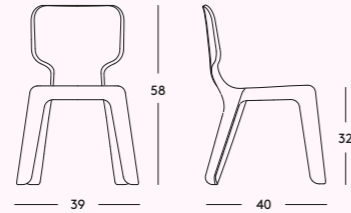

Matt colour
Yellow 1037 C



Matt colour
Green 1342 C



Matt colour
Brown 1478 C



Matt colour
White 1690 C

Little Flare — design Marcel Wanders, 2005

Children's table
Material: legs in standard injection-moulded polycarbonate transparent clear. Tops in MDF with white polymeric cover. Patterned tops also available. Pen holders in ABS. Sketch book available with patterns to be completed and coloured.

→ 46

Mesa para niños
Material: patas en policarbonato transparente neutro moldeado por inyección estándar. Tablero en MDF recubierto con lámina polimérica blanca. Disponible también tablero decorado. Portaplapices en ABS. Disponible también álbum con gráficas para completar y colorear.

Table pour enfants
Matériaux: pieds en polycarbonate transparent cristal, moulé par injection standard. Plateaux en MDF avec revêtement en polymère blanc. Plateaux décorés sont aussi disponibles. Porte-plumes en ABS. Disponible aussi album avec décorations à compléter et colorier.

Kindertisch
Material: Tischbeine aus transparentem Polykarbonat, farblos. Hergestellt im Standard-Einspritzverfahren. Tischplatten aus MDF mit weiss polymerer Folie überzogen. Tischplatten auch mit Dekoren erhältlich. Stiftbox aus ABS. Skizzenblock separat erhältlich.

Tavolo per bambini
Materiali: gambe in policarbonato trasparente neutro stampato ad iniezione standard, piano di MDF rivestito di foglia polimerica bianco. Piano anche con decori. Vaschette portapenne in ABS. Disponibile album con grafiche da completare e colorare.

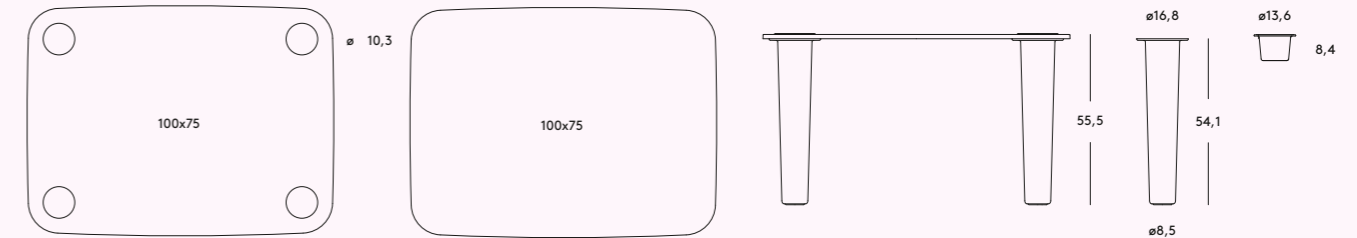

Linus — design Javier Mariscal, 2006

Children's tables
Material: legs in polypropylene with glass fibre added. Standard injection-moulded. Top in MDF with polymeric cover.

→ 40

Mesas para niños
Material: patas en polipropileno reforzado con fibra de vidrio moldeado por inyección estándar. Tablero en MDF cubierto con lámina polimérica.

Tables pour enfants
Matériaux: pieds en polypropylène chargé avec fibre de verre moulé par injection standard. Plateau en MDF avec revêtement en polymère.

Kindertische
Material: Gestell aus Polypropylen mit Glasfaser verstärkt. Hergestellt im Standard-Einspritzverfahren. Tischplatte aus MDF mit polymerer Folie überzogen.

Tavoli per bambini
Materiali: gambe in polipropilene caricato di fibra di vetro stampato ad iniezione standard. Piano in MDF rivestito di foglia polimerica.

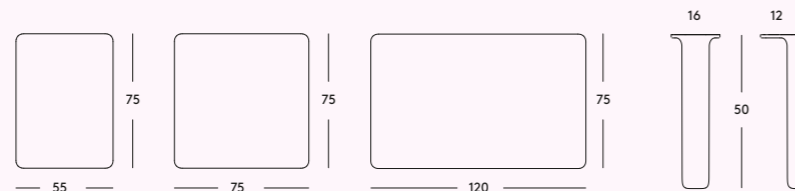

Matt colour
White 1690 C



Top
White 8500
Pen Holder + Feet
Orange 1001 C

Le Chien Savant — design Philippe Starck, according to an idea of C. Bavaud, 2013

Children's chair/desk
Material: rotational-moulded polyethylene. Suitable for outdoor use.

→ 18/19



Asiento/escriptorio para niños
Material: polietileno por moldeo rotacional. Apto para el exterior.

Chaise/bureau pour enfants
Matériaux: polyéthylène moulé par rotation. Conçu pour l'extérieur.

Kinderstuhl/-schreibtisch
Material: Polyäthylen. Hergestellt im Rotationsverfahren. Auch für den Aussenbereich geeignet.

Seduta/scrittoio per bambini
Materiali: polietilene stampato in rotational moulding. Adatto anche per esterni.

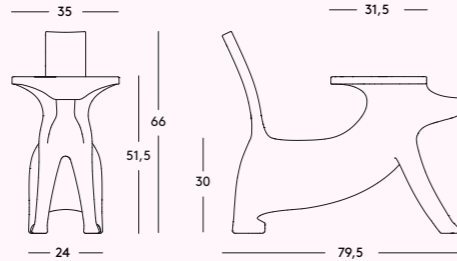

Matt colour
Green 1315 C



Matt colour
Yellow 1569 C



Matt colour
Pink 1628 C



Matt colour
Orange 1647 C



Matt colour
White 1735 C

Mico — design El Ultimo Grito, 2006

A diverse, multi-purpose object
Material: rotational-moulded polyethylene. Suitable for outdoor use.

→ 36/37



Objeto diferente, polivalente
Material: polietileno por moldeo rotacional. Apto para el exterior.

Objet divers, polyvalent
Matériaux: polyéthylène moulé par rotation. Conçu pour l'extérieur.

Andersartiges Mehrzweckobjekt
Material: Polyäthylen. Hergestellt im Rotationsverfahren. Auch für den Aussenbereich geeignet.

Oggetto diverso, polivalente
Materiale: polietilene stampato in rotational moulding. Adatto anche per esterni.

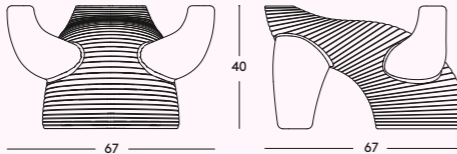

Matt colour
Red 1004 C

Flying Carpet — design Eero Aarnio, 2006

Flying carpet Rocking.
Material: base in rotational-moulded polyethylene. Suitable for outdoor use. Option extra: carpet in coloured polyamide.

→ 22/23

Alfombra voladora
Plataforma con movimiento oscilatorio circular. Material: plataforma en polietileno por moldeo rotacional. Apta para el exterior. Extras: alfombra en poliamida colorada.

Tapis volant.
Plateforme à bascule. Matériaux: plateforme en polyéthylène moulé par rotation. Conçu pour l'extérieur. Optionnel: tapis en polyamide coloré.

Fliegender Teppich
Schwingende Plattform. Material: Plattform aus Polyäthylen. Hergestellt im Rotationsverfahren. Auch für den Aussenbereich geeignet. Optional: Teppich aus farbigem Polyamid.

Tappeto volante
Piattaforma con movimento oscillatorio circolare. Materiale: piattaforma in polietilene stampato in rotational moulding. Adatto anche per esterni. Optional: tappeto in poliammide colorato.

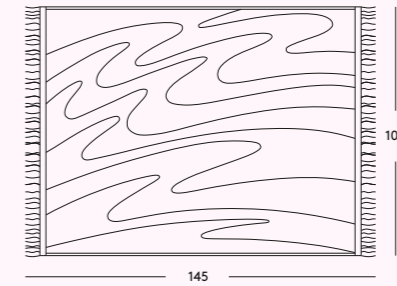
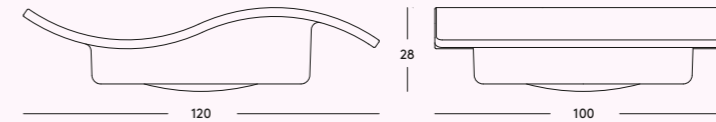

Matt colour
White 1700 C

Sunny Day — design Rea Aarnio-Gibson, 2007

Carpet
Material: coloured polyamide.

→ 34/35

Alfombra
Material: poliamida de color.

Tapis
Matériaux: polyamide coloré.

Teppich
Material: Polyamid, farbig.

Tappeto
Materiale: poliammide colorato.

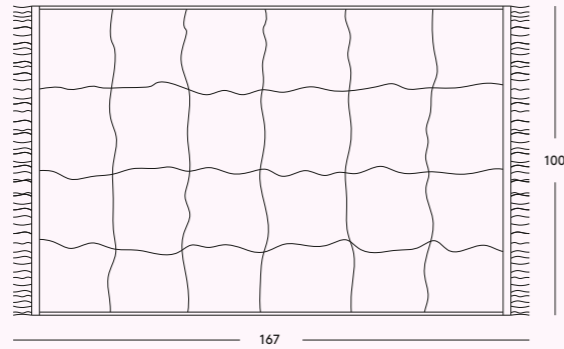

Bunky — design Marc Newson, 2012

Bed/bunk bed
Material: rotational-moulded polyethylene. Mattress, mattress cover, pillow, pillow cover and sheets also available.

→ 12/13

Cama/litera
Material: polietileno por moldeo rotacional. Disponible también colchón, funda de colchón, almohada, funda de almohada y juego de sábanas.

Lit/lit superposé
Matériaux: polyéthylène moulé par rotation. Matelas, drap-housse, coussin, taie, coussin et série de draps aussi disponibles.

Bett-Etagenbett
Material: Polyäthylen, hergestellt im Rotationsverfahren. Matratze, Spannüberzug für Matratze, Kissen, Kissenbezug und Set von Bettlaken separat erhältlich.

Letto/letto a castello
Materiale: polietilene stampato in rotational moulding. Disponibile anche materasso, coprimaterasso, cuscino, federa e set lenzuola.

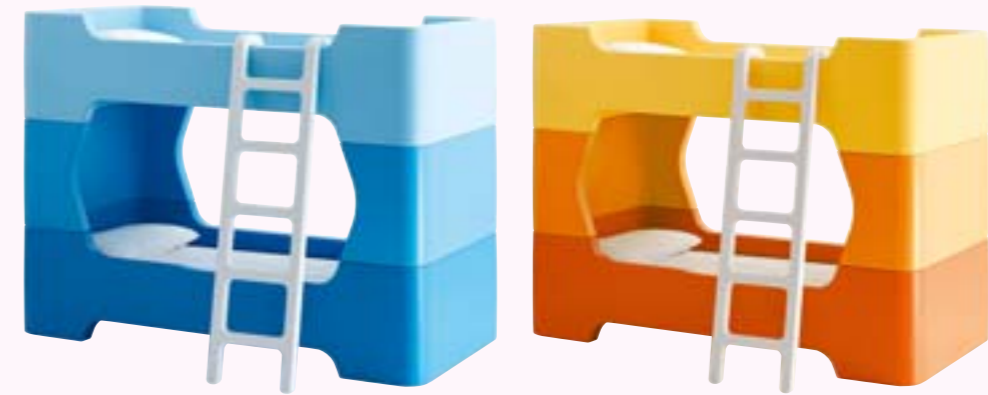
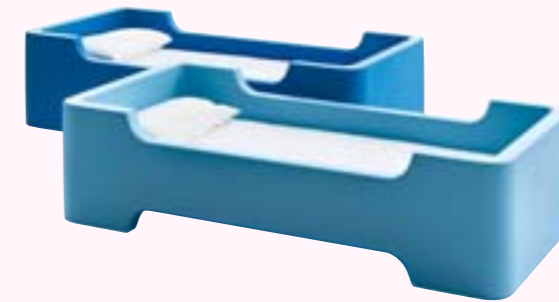
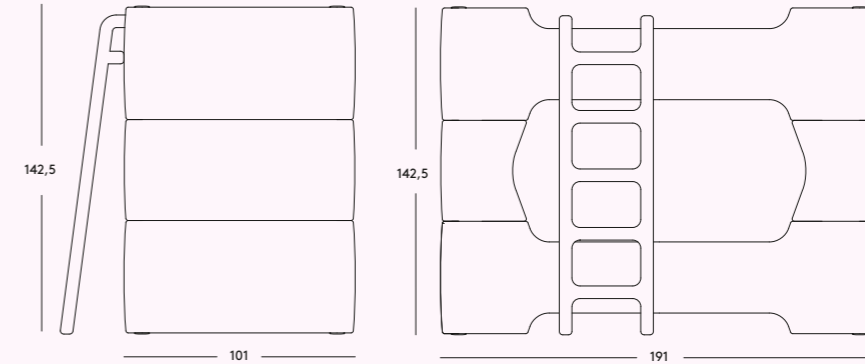

Ladder
White 1736 C

Bed 1
Dark blue 1232 C
Stacking Unit
Blue 1226 C
Bed 2
Light blue 1218 C

Bed 1
Dark orange 1656 C
Stacking Unit
Orange 1654 C
Bed 2
Light orange 1652 C

Summer to Spring — design El Ultimo Grito, 2005

Collection of children's clothes
100% made in Italy.
Available in three different sizes (for children ages 2 to 7). Material: cotton.

Colección de ropa para niños
100% hecha en Italia.
Disponible en tre tallas (para niños de 2 a 7 años). Material: algodón.

Collection de vêtements pour enfants
100% made in Italy.
Disponibile en trois tailles différentes (pour enfants de 2 à 7 ans). Matériaux: coton.

Kinderkollektion
100% made in Italy. In drei verschiedenen Größen erhältlich (für Kinder von 2 bis 7 Jahren). Material: Baumwolle.

Abbigliamento per bambini
100% made in Italy.
Disponibile in tre taglie (per bambini dai 2 ai 7 anni). Materiale: cotone.

→ 30/31

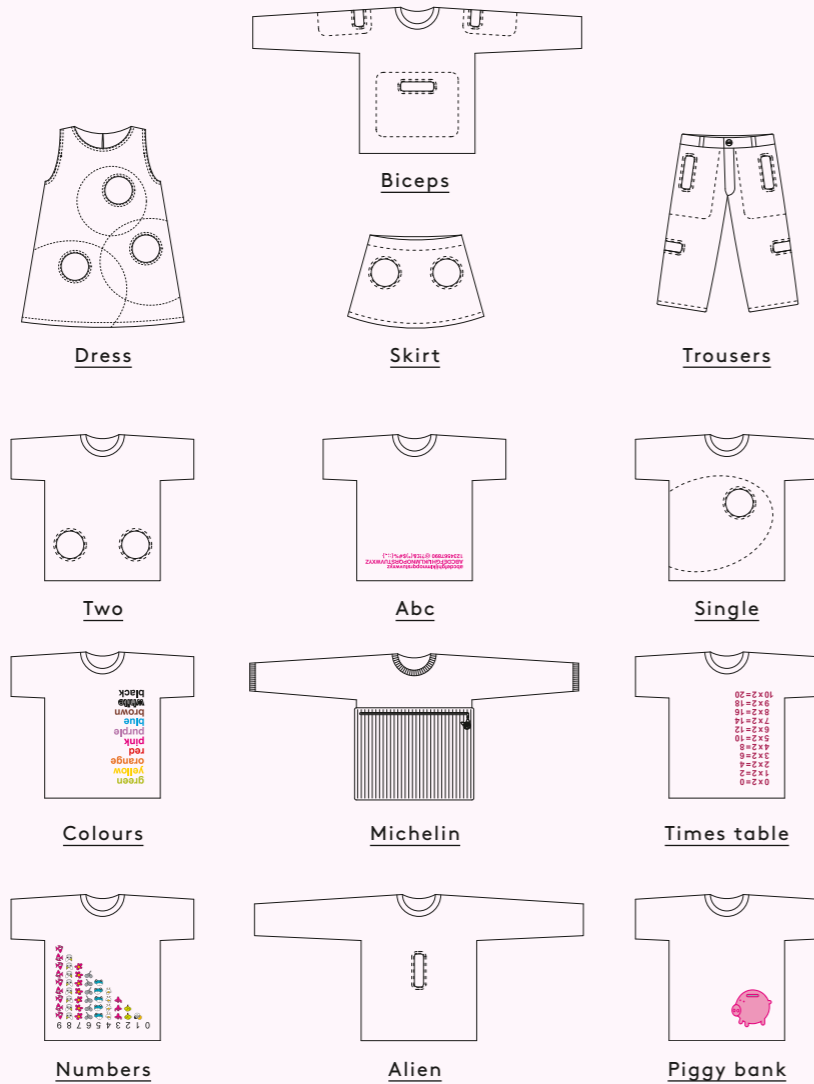

Paradise Tree — design Oiva Toikka, 2009

Coat stand
Material: elements in rotational-moulded polyethylene. Weight and inner frame in galvanized steel.

Percha de pie
Material: polietileno por moldeo rotacional. Lastre y estructura interior en acero cincado en frío.

Porte-manteaux
Matériaux: polyéthylène moulé par rotation. Lest et structure intérieure en acier galvanisé.

Kleiderständer
Material: Polyäthylen. Hergestellt im Rotationsverfahren. Gewicht und Innengestell aus verzinktem Stahl.

Appendiabiti
Materiali: polietilene stampato in rotational moulding. Zavorra e struttura interna in acciaio zincato a freddo.

→ 33

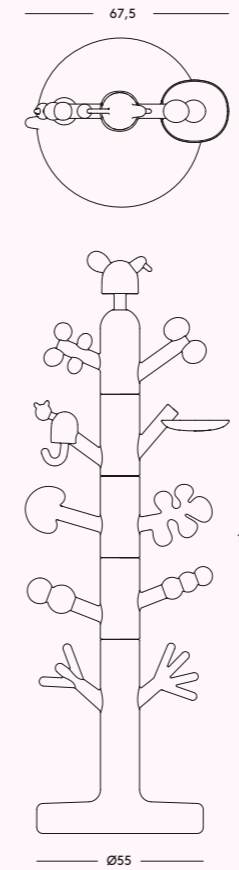

My Space — design Björn Dahlström, 2005

Space divider
Material: base in blow-moulded polyethylene. Frame in extruded PVC. Polyester fabric.

→ 54

Panel divisorio
Material: base en polietileno en blow-moulding. Estructura en PVC extruido, tela en poliester.

Diviseur d'espaces
Matériaux: base en polyéthylène moulé par soufflage. Structure en PVC extrudé. Tissu en polyester.

Trennwand
Material: Fuss aus Polyäthylen. Hergestellt im Blow-Moulding Verfahren. Gestell aus extrudiertem PVC. Polyesterstoff.

Pannelo divisorio
Materiali: base in polietilene in blow moulding, stelo in PVC estruso, telo in poliester.

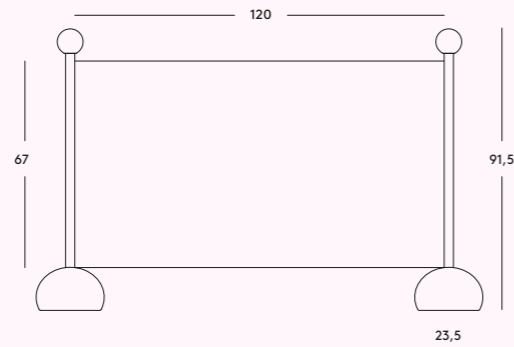

Decoro A



Decoro B



Decoro C



My House — design Björn Dahlström, 2005

Curtain-cum-tablecloth
Material: polyester.

→ 55

Mantel/cortina
Material: poliester.

Rideau/nappe
Matériaux: polyester.

Vorhang/Tischdecke
Material: Polyester.

Tovaglia/tenda
Materiale: poliester.

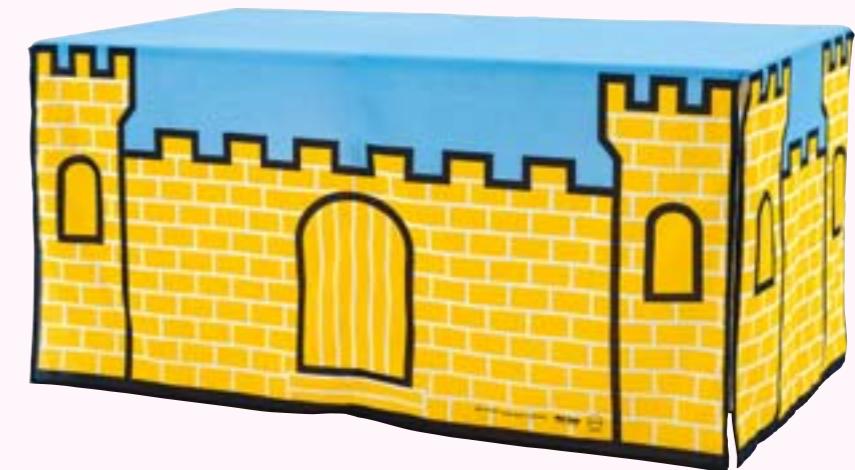
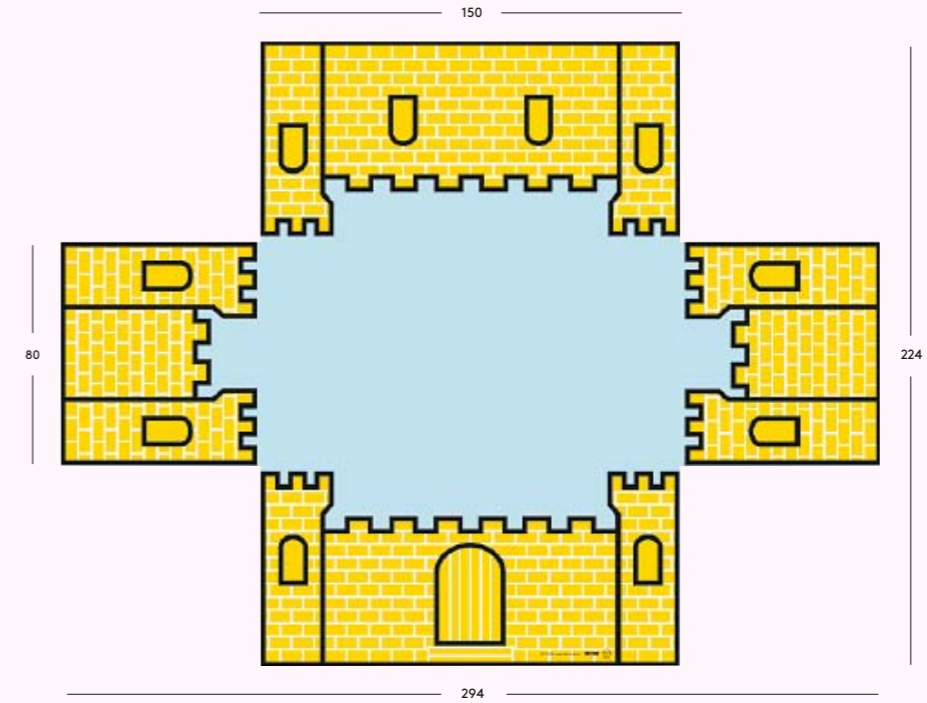

Eur — design Giulio Iacchetti, 2013

Shelving system. Stacking and adjoining
Material: sintered expanded polypropylene.

Libreria modular apilable y arrimable
Material: polipropileno expandido sinterizado.

Étagère modulable
Matériaux: polypropylène expansé sintérisé.

Modulares Ragalsystem, stapelbar und addierbar
Material: gesintertes geschäumtes Polypropylen.

Modulo libreria, impilabile ed accostabile
Materiali: polipropilene espanso sinterizzato.

→ 43

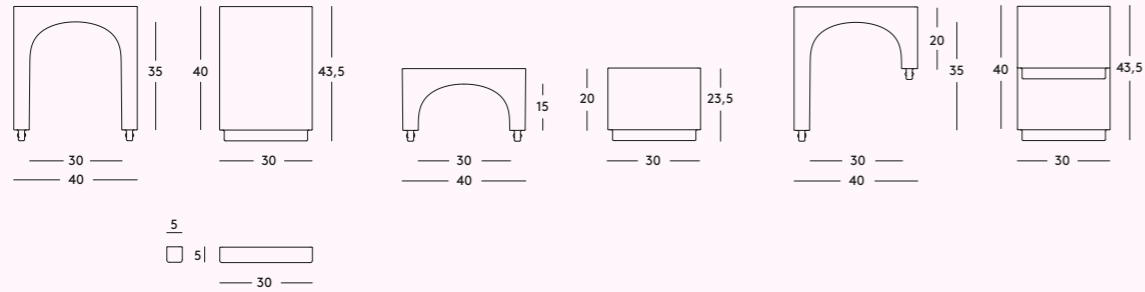

Colour
Terracotta 1092 C

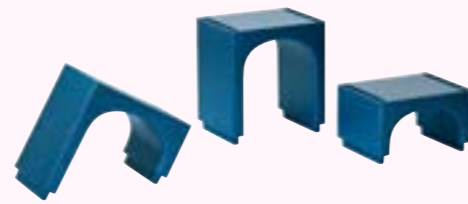

Colour
Blue 1606 C



Examples of Composition

Tuttifrutti — design Stefano Giovannoni, 2000

Stacking basket
Material: standard injection-moulded SAN. Can be supplied with wheels.

Contenedor porta-objetos apilable
Material: SAN moldeado por inyección estándar. Ruedas también disponibles.

Corbeille porte-objets empilable
Matériaux: SAN moulé par injection standard. Livrable aussi sur roulettes.

Allzweckkiste, stapelbar
Material: SAN, hergestellt im Standard-Einspritzverfahren. Auch mit Rollen lieferbar.

Cassetta portaoggetti impilabile
Materiale: SAN stampato ad iniezione standard. Anche su ruote.

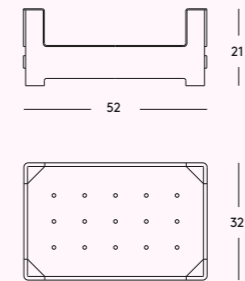

Transparent colour
Orange 2510 TR

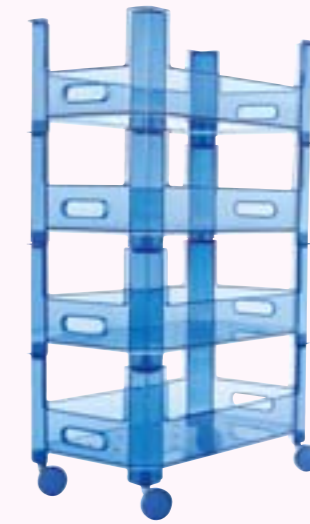

Transparent colour
Blue 2530 TR

Ladrillos — design Javier Mariscal, 2005

Shelving system

Material: shelf supports in rotational-moulded polyethylene. Shelves in HPL white with black edge.

→ 45

Libreria modular

Material: ladrillos en polietileno por moldeo rotacional. Estantes en laminado HPL blanco, borde negro.

Système d'étagère

Matériaux: briques en polyéthylène moulé par rotation. Plateaux en HPL blanc avec bord noir.

Regalsystem

Material: Abstandshalter aus Polyäthylen. Hergestellt im Rotationsverfahren. Ablagen aus HPL weiss mit schwarzer Kante.

Libreria componibile

Materiali: mattoni in polietilene stampato in rotational moulding. Piani in HPL bianco con bordo nero.

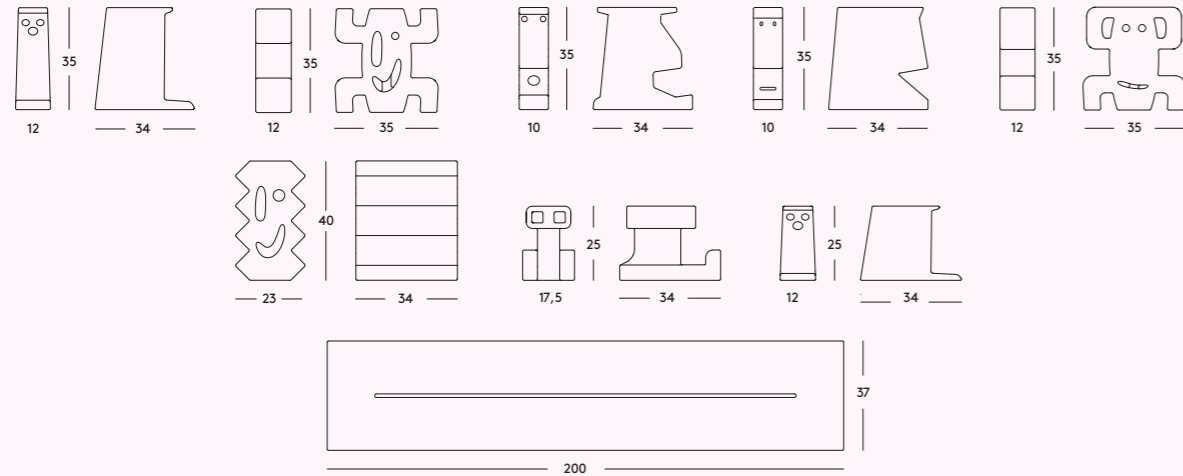
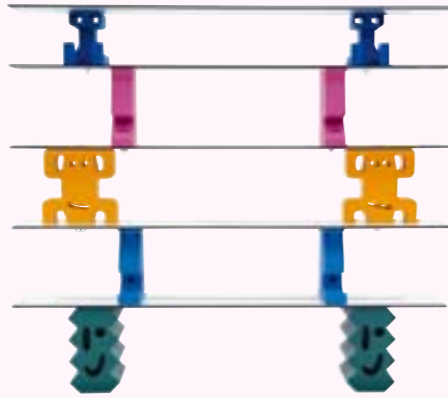

Shelf Supports Nik fuchsia 1006 C



Shelf Supports Nomo yellow 1025 C



Shelf Supports Nomi orange 1085 C



Shelf Supports Nono light blue 1220 C



Shelf Supports Nosi blue 1252 C



Shelf Supports Sino dark green 1281 C



Shelf Supports Nok green 1360 C



Shelf Supports Nolu pink 1623 C

Downtown — design Oiva Toikka, 2011

Shelving system

Material: rotational-moulded polyethylene. Suitable for outdoor use.

→ 15



Libreria

Material: polietileno por moldeo rotacional. Apto para el exterior.

Bibliothèque

Matériaux: polyéthylène moulé par rotation. Conçue pour l'extérieur.

Regalsystem

Material: Polyäthylen. Hergestellt im Rotationsverfahren. Auch für den Aussenbereich geeignet.

Libreria

Material: polietilene stampato in rotational moulding. Adatta anche per esterni.

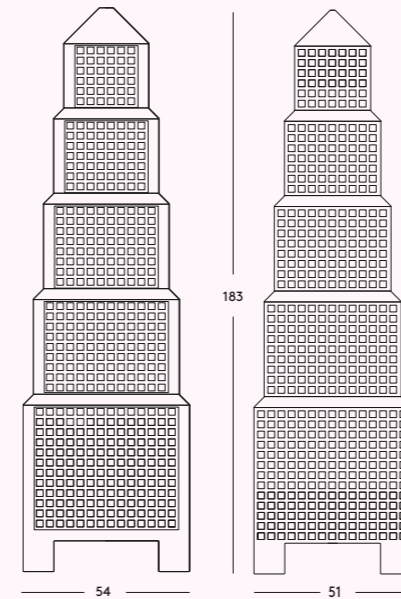

Matt colour White 1736 C

Nido — design Javier Mariscal, 2005

Nest/cave

Material: rotational-moulded polyethylene. Floor with grass style pattern and graffiti on underside of roof. Suitable for outdoor use.

→ 50/51



Guarida

Material: polietileno por moldeo rotacional. Suelo con diseño de hierba y techo con grafiti. Apto para el exterior.

Nid/repaire

Matériaux: polyéthylène moulé par rotation. Sol avec décoration herbe et plafond avec graffiti. Conçu pour l'extérieur.

Höhle

Material: Polyäthylen. Hergestellt im Rotationsverfahren. Fussboden mit grasähnlichem Dekor, Decke mit Graffiti. Auch für den Aussenbereich geeignet.

Tana

Materiale: polietilene stampato in rotational moulding. Pavimento con disegno erba e soffitto con graffiti. Adatta anche per esterni.

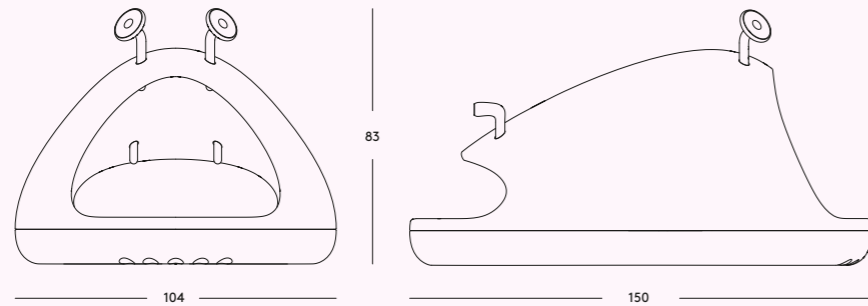

Roof
Yellow 1025 C
Base
Green 1290 C
Antennae
Grey anthracite 1420 C

Villa Julia — design Javier Mariscal, 2009

Small house

Material: cardboard. Complete with stickers for personalization.

→ 52/53

Casita

Material: cartón. Dotada de pegatinas para la personalización.

Petite maison

Matériaux: carton. Fourni avec adhésifs pour la personnalisation.

Kleines Haus

Material: Karton. Komplett mit Aufklebern zur Eigengestaltung.

Casetta

Materiale: cartone. Completa di adesivi per la personalizzazione.

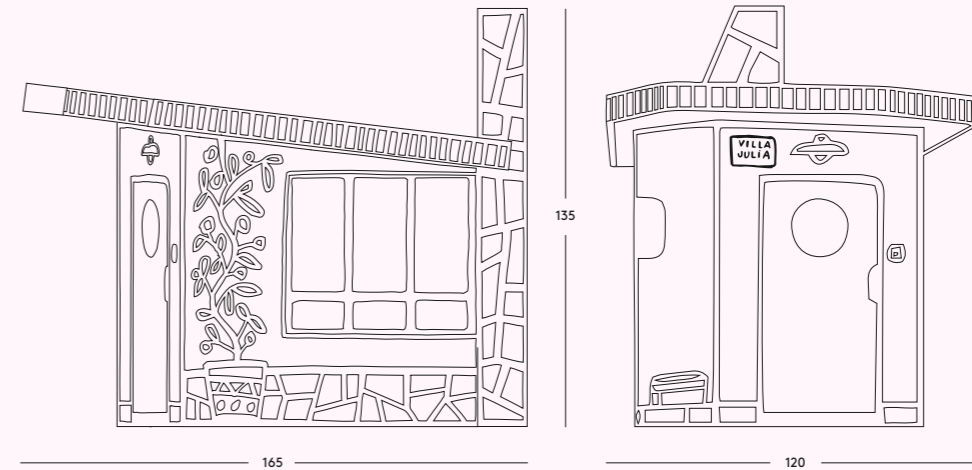

Matt colour
White

My First Office — design Martí Guixé, 2012

Play/learning space
Complete with desk
adjustable in height.
Material: birch plywood.

Espacio de juego-estudio
Dotado de mesa con
altura regulable.
Material: multiestrato de
abedul.

Espace jeu/étude
Fourni avec petit bureau
régable en hauteur.
Matériaux: bouleau
multiplis.

Spiel- oder Arbeitsfläche
Komplett mit
höhenverstellbarem
Schreibtisch.
Material: Birkenschichtholz.

Spazio-gioco, spazio-
studio
Completo di scrittoio
regolabile in altezza.
Materiale: multistrato di
betulla.

→ 48/49

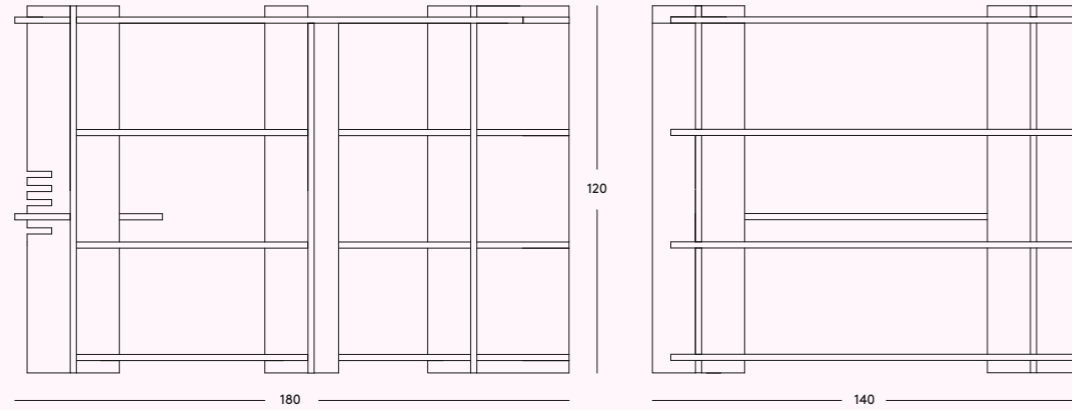

Football Tape — design Martí Guixé, 2004

Adhesive tape to make
paper balls
Material: acrylic
polypropylene. Non-toxic.

Cinta adhesiva para crear
balones de papel
Material: polipropileno
acrílico. No tóxico.

Ruban adhésif pour faire
des ballons en papier
Matériaux: polypropylène
acrylique. Non toxique.

Klebeband, um
Papierbälle zu machen
Material:
Acrylpolypropylen.
Atoxisch.

Nastro adesivo per creare
palloni di carta
Materiale: polipropilene
acrílico. Atossico.

→ 56/57

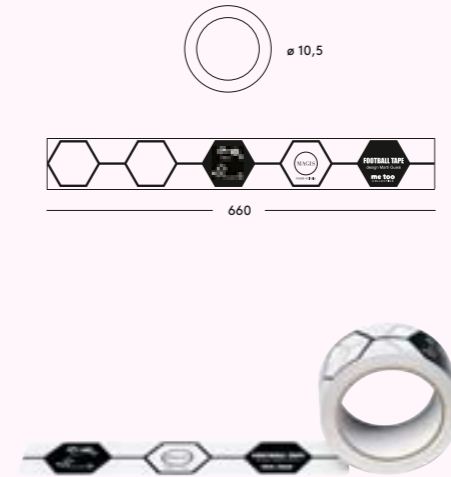

Puzzle carpet — design Satyendra Pakhalé, 2005

Puzzle carpet
Material: soft expanded
polyethylene coupled with
polyester fabric.

Azulejo/alfombra
Material: polietileno
expandido morbido
cubierto con tela de
poliéster.

Tapis/puzzle
Matériaux: polyéthylène
expansé souple avec tissu
en polyester.

Puzzle/Teppich
Material: weiches
geschäumtes Polyäthylen
mit Polyesterstoff.

Piastrella/tappeto
Materiale: polietilene
espanso morbido
accoppiato di tessuto
poliestere.

→ 11/46

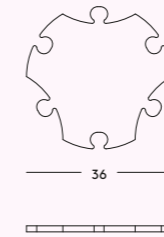

Patterns
Water



Patterns
Sand



Patterns
Grass

Moments of Ingenuity — design Oiva Toikka, 2011

Serigraphy

Five colours
(The Elephants) or seven
colours (The Camel and
the Ostrich) art serigraphy,
printed on Fabriano
Rosaspina 285 gr paper
and mounted
on a MDF support.

Serigrafía

Serigrafía de arte en 5
colores (Los Elefantes) o
en 7 colores (El Camello
y el Avestruz) impreso en
papel Fabriano Rosaspina
de 285 gr y montado en un
soporte de MDF.

Sérigraphie

Sérigraphie d'art à 5
couleurs (Les Éléphants) ou
à 7 couleurs (Le Chameau
et l'Australie) imprimée sur
papier Fabriano Rosaspina
285 gr et montée
sur support en MDF.

Serigraphie

Fünffarbige (Die Elefanten)
oder siebenfarbige (Das
Kamel und der Strauss)
Kunstserigraphie,
auf Fabriano Rosaspina 285
gr. Papier gedruckt und auf
ein MDF Tafel geklebt.

Serigrafia

Serigrafia d'arte a 5 colori
(Gli Elefanti) o 7 colori (Il
Cammello e lo Struzzo)
stampata su carta
Fabriano Rosaspina 285
gr e montata su supporto
di MDF.

→ 16/43



100

The Elephants



100

The Camel and the Ostrich

All rights reserved.
No part of this publication
may be reproduced, stored
in a retrieval system
or transmitted, in any form
or by any means, electronic,
mechanical, photocopying,
recording or otherwise,
without the prior permission
of Magis Spa.
Magis reserves the right to
introduce any changes
to its own models, without
prior notice.

Graphic design:
Designwork
Photography:
Max Rommel (location)
styling Vanda Gemino
post producer Studio Dilux
Tom Vack (still life)
Pasquale Abbattista
(page 56)
Colour separation
Lucegroup

Printed in Italy by
OGM, Padova

@Magis Spa 2014

Magis Spa
via Triestina, Accesso E
Z.I. Ponte Tezze
30020 Torre di Mosto
Ve - Italia
T +39 0421 319600
F +39 0421 319700
e-mail: info@magisdesign.com
www.magisdesign.com



Magis Spa
via Triestina, Accesso E
Z.I. Ponte Tezze
30020 Torre di Mosto
Ve - Italia
T +39 0421 319600
F +39 0421 319700
e-mail: info@magisdesign.com
www.magisdesign.com

