



SITS
— *comfortable life*



TABLE of Contents

ABBE	168	248	LILY	154	258
AGDA	24	184	LINDA	172	258
ALASKA	166	249	LINN	132	222
ALEX	74	184	LINUS	20	193
ALLAN	48	184	LISA	64	194
ALMA	66	184	LOTTA	116	223
ANTARES	104	212	LUDVIG	40	194
AXEL	82	212	LUKAS	120	223
			LUNA	134	225
BARI	122	213			
BRANDON	162	250	MAJA	10	195
			MALIN	90	226
CAPRICE	42	185	MATTIAS	38	196
CIRCLE	106	213	MAX	72	198
CLARK	62	186	MIA	178	260
CLOUD	164	252	MILANO	110	228
COLORADO	160	253	MOKKA	52	198
CUBIC	34	186	MYNTA	109	230
DIANA	138	214	NEPPI	108	231
DONNA	70	187	NEW YORK	170	261
DORIS	22	187	NINA	56	198
ELSA	50	188	OHIO	28	199
			OLLE	84	232
FATTY	180	254	OSCAR	156	261
FOXI	60	188	OTTO	16	200
GINEVRA	58	188	PASSION	100	232
GIORGIO	96	215	POLA	46	201
GRETA	124	215	POPPY	12	201
			PUK	118	234
HEAVEN	174	254			
HEBE	136	216	QUATTRO	98	234
HUGO	8	189			
HUMPHREY	126	217	RASMUS	86	237
			ROSE	158	262
IMPULSE	32	189	RUCOLA	44	205
IVY	14	190			
			SARA	146	262
JENNY	80	217	SHELL	54	205
JULIA	148, 150	255	STEFANI	76	205
JUSTUS	30	191	STELLA	92	237
KAJSA	176	256	TOKYO	36	206
KALLE	114	218			
KATO	68	192	VARIO	102	239
KLARA	88	219	VENEZIA	128	245
KORIANDER	112	221	VIGGO	130	245
			VILLE	18	208
LENA	152	256	VINCENT	94	245
LEO	144	257			
LEON	140	222	WATSON	127	245
LIAM	26	192			



DEAR

Clients, Colleagues, Agents, and Designers.

Update of the Catalog. Last two years SITS has continued to develop as one of the leading upholstery producer in Europe. Our intelligent Eton system, that transport the parts to be sewed together high under the ceiling and decide by itself who of the sewers that fits best to do the work, is now fully implemented. The look coming into the sewing department is like Disney World, spectacular and efficient. Many other improvements have been made in all areas and we will continue this work of fulfilling the expectations from our clients and ourselves.

Our markets are increasing and we strive always to renew our sofa and table collections. With design and expression of our furniture we stay in the frontline of the Scandinavian style with the mission to satisfy our clients and stay true to our identity.

SITS values remains.

Honesty, Respect, Fairness, Quality, Service, Environmental Awareness and Equal rights to all humans.

The expression 'What YOU do makes a difference' is more valid today, 2016, then ever.

Enjoy the catalog!

Erik Näsström

Majje Näsström



The time is 19:50. The loft apartment is perfectly cleaned, the canapés are perfectly placed and you are now pouring the cocktails. You put on some lipstick and push play on the playlist. The expectations and excitement are high and any minute now the doorbell will ring and the party can start...

The world of COCKTAIL & DESIGN is all about fun and diversity of design, fabric and colours. It's the most frequent place where you can meet your friends and also the most energetic element of your home. We provide you with a product that has a strong unique personality and likes to show off. In this world you have all the possibilities and the only thing that can stop you is your imagination.

Inspirational Life!



cocktail & design

HUGO



Simple cushion structure. The high resilient foam guarantees comfort and the smooth look of the seat and rear surfaces. A choice of comfort lux or standard cushions with stitching provides an individual and sensual touch.

designed by Ian Archer

HUGO, 3 seater, Roma 63 grey

>>189

MAJA

The sofa designed by Ian Archer. A wonderful shape with original armrests. Its structure of wooden or metal legs reflect a retro style. Special features: thick piping and corrugation.

designed by Ian Archer

MAJA, 2 seater, Classic Velvet 14 lime

>>195





>>201

POPPY

POPPY is representing SITS romantic collection. However, its rounded shapes, buttons, pillows and beautiful sense of proportions doesn't exclude its high comfort and usability in everyday life. It's all thanks to many options of POPPY that can be chosen. Two types of backrest pillows are much more than-a detail.

- POPPY 2, 3 seater with 2 seat cushions, Panno 1000 light grey
- POPPY 1, 3 seater with 2 seat cushions, Lila 12 green
- POPPY 2, chaiselongue freestanding right, Panno 2274 light turquoise

designed by Niels Gammelgaard



IVY is SITS idea of what romantic style can be in 21th century. Interesting shape of IVY back is something that allows to present it in places where all furniture can be seen. Pillows are the invitation for relax in warm and cozy atmosphere.

designed by Petra Lassenius

IVY, 2,5 seater, Zara 02 beige

>>190



OTTO

What makes OTTO special is Scandinavian look with a reminiscence of design of '50. Buttons are a stylish detail. Client can choose its color and play with the fabrics to achieve an unique composition. 'Charming' is a good term that gives a feeling what OTTO is.

OTTO, 3 seater, Panno 2048 storm blue

>>200





>>208

VILLE

The most striking detail you can see in this model is the piping in contrast to the color. It is an unusual composition. The designers have created two versions of cushions: with and without buttons. We have also two different feet for the VILLE, it is uncommon end result.

designed by Ian Archer

VILLE, 2 seater with buttons, Velluto 0706 dark grey

LINUS

The simple, modern sofa designed with precision in every detail. The metal feet create the special, light look. Furniture produced only as fix cover, but two different upholstery: fabric or leather. LINUS provides extraordinary comfort due to DYNAFLEX.

LINUS, 3 seater, Darwin 25 grey

>>193

DORIS



DORIS is designed by Dan Ihreborn.
The softness shows the character of this sofa. The frames can be in different colors -
chrome or painted versions: black or grey - to accentuate the individual look.

designed by Dan Ihreborn

DORIS, 3 seater, Caleido 1419 natur

>>187

AGDA

AGDA is designed by Kasper Meldgaard & Nikolaj Duve.
The designers work for the 'Say Who' brand.
It is a straight sofa with a soft shape and soul,
perfect for any living room.

designed by SAYS WHO

>>184



LIAM is one of our models which surely will fit into any apartment thanks to the unlimited arrange possibilities. You are able to choose from our range of freestanding and connectable elements as well as some ready and recommended sets. In this model we have used our new comfort option, a special silicone balls which provide the best comfort and are allergen free.

LIAM, arrangement, Zen 4 light grey

>>192

LIAM

OHIO

Designed for modern interiors, sophisticated in terms of design and modular furniture. OHIO elements can be arranged by yourself or choose from 11 suggested sets. The minimalism of its design does not exclude comfort, OHIO uses thicker seat cushions. Select the cushion interiors as either highly flexible foam or natural down. Chrome-plated legs emphasize the modern looks of OHIO.

>>199

JUSTUS

JUSTUS combines a geometric shape with soft, delicate, feather-filled seats. This combination has produced excellent results - we have created a modern yet highly practical piece of furniture. JUSTUS comes with wide armrests. The use of a frame with metal legs accentuates the modern design of the item. The collection consists of many items that can be freely arranged to create a variety of design arrangements.

designed by Niels Gammelgaard

JUSTUS, 3 seater, Zara 15 dark grey

>>191

IMPULSE

The light shape of this sofa contains a great deal of style. IMPULSE will enchant you with its simplicity and character. The modern style of this collection can be enhanced with one of two types of metal legs or toned down with wooden features. You are also free to decide on the shape of the body of the sofa by choosing from two types of armrests, armrest cushions as an addition, or a fixed or removable cover. All this will help you give the furniture your unique style.

IMPULSE - stand out with your style.

IMPULSE,
3 seater, Caleido 1424 black
3 seater, Caleido 1419 natur

>>189

CUBIC



CUBIC - minimalism in a friendly way. -
The cubic shape of the seats is made gentle by original stitching. This is a stylish decorative feature of the exceptionally large surfaces of the seats, and the highly-elastic foam that fills the seats will be sufficient proof for everybody - of the comfort of the CUBIC furniture. As regards the choice of the backrests, there is a wide range of solutions two types of cushions and four types of the top surfaces. The seat and armchair items are available in two sizes, which makes CUBIC suitable for both small and spacious rooms.

CUBIC - tamed minimalism.

CUBIC, arrangement, Himalaya 3 grey-beige

>>186

TOKYO



>>206

Soft and modern line of modular furniture whose multiplicity of elements allows to arrange any room. Spectacular arrangement solutions and top quality materials are the attributes that will give this perfect touch to your living room.

designed by Niels Gammelgaard

TOKYO, set 14 left, Himalaya 3 grey-beige

MATTIAS gives an opportunity for unusually innovative arrangement of the interiors. The chaiselongues, benches, sofas and cushions in various sizes guarantee much freedom in arranging the furniture. The back cushions with rollers on the inner side constitute a very interesting solution. They facilitate an original arrangement of corner settee backs - instead of the right angle, which may not always be comfortable, it is now possible to create gentle slopes and curves.

MATTIAS, set 5 right, Panno 1000 light grey

>>196

MATTIAS

LUDVIG



Perfect proportions, modern and light look. Those are the most important features of LUDVIG from COCKTAIL & DESIGN collection. It suites modern interiors but will be also a good choice for more traditional clients, who value simplicity. LUDVIG provides extraordinary comfort due to DYNAFLEX.

LUDVIG, 3 seater (2 cushions), Zen 3 black-white

>>194



CAPRICE



>>185

The beautiful, modern sofa. Very elegant and original. The special sewing is very characteristic. CAPRICE looks very light. Two types of comfort: standard and lux, two types of covers: fix and loose, wooden or metal legs allow to choose the correct sofa or corner.

CAPRICE, set 4 right, Caleido 2934 dark grey

RUCOLA - comfortable and neat cushions on a gently profiled sofa. RUCOLA is a piece of furniture designed for mature users. The seat placed at the right height and the appropriately tough cushions make the sofa uniquely comfortable. Its beautifully formed legs give support to RUCOLA and elevate its body to the right level, while the perfect proportions give the chair its classic look.

RUCOLA - an addition of taste.

designed by Ian Archer

RUCOLA, 3 seater, Sobral 07 olive

>>205



RUCOLA

POLA



POLA has been designed for enthusiasts of traditional forms with a modern look. The classic origin of this sofa manifests itself through its gentle, rounded line and the quilting on the backrest. Its modern character is proved by its light shape and high legs. To produce an additional decorative effect, the sofa can come with buttons in a colour different from that of the sofa.

>>201



POLA ARMCHAIR

POLA ARMCHAIR - a beautiful armchair with its style originating far in the past. However, thanks to the designer's imagination, POLA has been given a new look. It has been redesigned to create a piece of furniture with a classic line and a bit of obstreperous contrariness. Fine rounded surfaces combined with buttons in various colours on a traditionally profiled backrest produce a unique design effect.

POLA - noble origin.

POLA, armchair, Panno 1002 charcoal



ALLAN

ALLAN is an example of perfect design, where the designer bears in mind the basic functions of this piece of furniture - comfort and beauty. Despite its unique shape, this armchair will still surprise you with the harmony and comfort of using it. Its seat is tilted, producing the effect of an armchair 'frozen' for a moment before falling. The line of its wooden armrests has been so designed as to give stability to the shape.

ALLAN - unruly in form.

ALLAN, armchair, Paca ViVi turquoise

>>184



ELSA

Armchair with perfect proportions with very simple, but characteristic shape of armrests. The special neckrest pillow add the comfort. High and thin wooden legs are support for look and convenience. The best fabrics for ELSA are: Caleido, Panno and Amstel.

ELSA, armchair, Caleido 2994 light brown

>>188



MOKKA

Its round seat looks like a pouffe, but its ideally profiled backrest makes this piece of furniture perfectly suitable as a neat armchair. MOKKA is extremely comfortable and, at the same time, practical. With its small size, it's easy to carry around and move from one place to another, and it's also easy to produce different interior design arrangements. Once positioned in a place, it can dynamically change its position thanks to the use - in one of the available versions - of a swivel mechanism. Another available version is a MOKKA with slippers discreetly concealed under the seat.

MOKKA,
armchair espresso swivel, Tahiti winter col. 2
armchair espresso swivel, Caleido 2990 powder pink
armchair espresso swivel, Caleido 2248 mint

>>198

SHELL

The wonderful shape of the seat and the unusually decorative base make SHELL a unique piece of furniture. The seat of the armchair will surround you, giving you a sense of comfort and peace. The light weight of the armchair is ensured by its base, which can be either a metal frame or a swivel leg. In either option, the armchair will shine and bring extra light into your interior. SHELL - shape and light.

SHELL, armchair swivel, Lila 12 green

>>205





NINA

NINA - an armchair with the power to create style. Its innovative reference to the classic designs of 1970s clearly makes NINA a piece of furniture suitable for interiors with the highest level of stylistic sophistication. The armchair's classic seat looks great when upholstered with any kind of fabric. The armchair can be based on either a classic leg or a gentle, modern frame.

NINA - your interior stylist.

designed by Niels Gammelgaard

NINA, armchair, Lila 6 turquoise

>>198

GINEVRA

>>188

GINEVRA is the queen who made quite a mess among the Round Table Knights at the side of legendary King Arthur. The armchair named after the queen will also arouse great interest. It's small, but its shape is truly unique. GINEVRA is a bit like a throne and a bit like an exhibit on display at a modern art museum. It will certainly attract everybody's attention. The unique shape of the seat doesn't mean it's not comfortable. The armchair is ergonomically shaped. It's made of highly-elastic foam and comes with lumbar cushions, which makes sitting in it a truly comfortable experience.





FOX I

The armchair takes inspiration from the style of the 70's. FOX I stands for simplicity and functionality. Its unique design is achieved thanks to the simplicity of the seat, and the use of one piece of wooden element, being the arm and at the same time the armchair leg. Imagination and creativity when choosing the upholstery for FOX I allows you to create an armchair that can be used to decorate any interior.

FOX I, armchair, Oasi beige

>>188

CLARK

CLARK is young in spirit, dynamic and helpful. CLARK is a chair with perfect proportions designed for any kind of interior. Its shiny steel frame for the seat is a decorative feature of this piece of furniture and gives the chair its stability. Its upholstered features offer unlimited design possibilities - CLARKS looks great when 'dressed' in plain or patterned fabric. A combination of soft fabric with cool metal legs produces an attractive design effect. The chair is also available with an armrest.

CLARK - the style for the young in spirit

designed by Niels Gammelgaard

CLARK, chair with armrests, Sony 7 turquoise

>>186



LISA



LISA - an armchair unique in form - a combination of modernity and tradition. Its wide backrest and classic legs make the perfect match with the originally profiled armrests and the surprising arrangement of buttons on it. The effect can be enhanced with buttons in a colour other than that of the backrest. The well-designed combination of modern and classic features is the greatest advantage of this armchair and makes it truly original.

LISA - contrast as a source of beauty.

LISA,
armchair, Amstel 5 l. turquoise
armchair, Amstel 3 pink

>>194



ALMA

ALMA - we have a recipe for comfort. The ingredients are as follows: a thick and springy seat, a soft back cushion with decorative buttons, and a rounded backrest that seems to embrace you. This is ALMA - the quintessence of comfort. Each part of this armchair can be made of a different type of fabric. Depending on the design climate of your interior, the armchair can have a classic frame with legs or come with a metal swivel leg.

ALMA - take the comfort home.

ALMA, armchair, Matrix white

>>184



KATO

>>192

KATO is extremely ergonomic armchair. High back and perfect proportions of armrests allow for a comfortable rest. Additionally the footstool is absolutely designed for the body shape - is a little leaning. Everything for ergonomic, for the special comfort. The best fabrics for KATO are: Caleido, Tahiti, Mogani and Panno.

KATO, armchair, footstool, Caleido 1524 aubergine





DONNA

Collection COCKTAIL & DESIGN is about fun and diversity of design, fabric and colours and strong unique personality. Armchair DONNA is the quintessence of what this category should be. It will make every interior unforgettable. DONNA is less than 100 cm high what makes it subtle. Footstool available to make it more comfortable.

DONNA,
armchair, Caleido 1497 light grey
armchair, Caleido 2248 mint

>>187

Perfect lines and lightness of style with an amply high back – it is MAX. Our COCKTAIL & DESIGN collection. The new chair in the SITS collection is designed by Ian Archer. Two versions of the armchair: with buttons or without. Available in fabric and leather.

MAX,
armchair, Classic Velvet 15 green
armchair, Luis 1 white
armchair, footstool, Yeti 9 black-white

designed by Ian Archer

>>198



MAX

ALEX



Tinny armrests, a back cushion and headrest pillow - this is ALEX, a simple armchair with simple details. Looking good in both calm and very saturated colors.

designed by Dan Ihreborn

ALEX, armchair, footstool, Mattis 49 light turquoise

>>184



STEFANI

An armchair with two types of legs: wooden and swivel with function, executed out of TILT mechanism. This armchair with its wooden legs reflects Scandinavian style. The swivel version suitable and stylish for public places or offices. It's the first model in SITS collection made with 100% pouring foam.

STEFANI,
armchair, Panno 2272 yellow
armchair, Panno 2274 light turquoise
armchair, Panno 2240 turquoise

>>205

designed by Niels Gammelgaard



In one part sits the teenager with his laptop on his knee, the youngest has fallen asleep in your lap while you and your friends are laughing and playing cards. Your husband comes and joins you with a refilled bowl of popcorn...

The world of HOME & FAMILY is a world of peace, love and joy. These are the magical moments with your family and friends. When meetings and discussions can last forever while the time flies and you don't need to worry about anything else but concentrating on the things that are the most important. We provide you with a product that will act as the meeting point in your home and you never have to worry about it's tenderness or that there isn't room for everyone in every generation.

Active Life!



home & family

JENNY

This model combines the attractive, timeless and functional look. Different cushions sizes and different looks of sofas, will make it possible for every user to find the right system for themselves. Choose a legs no 159 and expose JENNY like a very original style.

designed by Ian Archer

JENNY, 3 seater ver. B, armchair wide ver. C, Yeti 1 natur

>>217



AXEL

AXEL is designed by Ian Archer.
The simple shape of the cushions and feet give the sofa a Scandinavian style.
We have two types of cushions: shorter or wider, to create the individual look.

designed by Ian Archer

AXEL, 4 seater with short back cushions, Nancy 5 light grey

>>212



OLLE

>>232

It is a traditional sofa with very interesting armrest and cushion cover finishes. Back cushions filled with feathers and silicone in 'lux comfort' and silicone in 'standard comfort'. Specially shaped legs gives th OLLE its unique class.

OLLE, 3,5 seater round (2 cushions), Nilo 31 light grey



RASMUS



Traditional and ingenious - the best words to describe RASMUS. The well known shapes can be cleverly diversified by using two different fabrics on one piece of furniture. The checked fabric is recommended to make RASMUS glamorous. The characteristic legs creating the perfect effect.

RASMUS, 3 seater, Linen graphite

>>237

KLARA



The model with an unlimited number of possibilities.
Do you want a simple and classic piece of furniture – there you go!
This model combines the attractive, timeless and functional look.
Immerse yourself in your imagination and mix with your
arrangement of any room with our KLARA!

KLARA, 3 seater, Himalaya 3 grey-beige

>>219



MALIN

It is a simple, comfortable and cozy sofa.
What do you say to creating your place in the Scandinavian style?
It is a perfect choice for you. Choose bright colors to make it complete.
You are able to select any configuration with any fabric in one fix cover.

MALIN, set 9 left, Risco/Runner 11 grey

>>226

STELLA



If you want to create a romantic style in any room, choose our STELLA. The stitching on the armrests creates the unique style. Slanting armrests compliment the unique style. STELLA suits a modern environment as well as traditional cosy interiors.

STELLA, set 2 left, Mattis 45 blue

>>237



VINCENT

An original design, a wooden frame, soft comfort and size - a few words about the sofa.
The most important element is the dymetrol hidden inside. VINCENT is a piece of classic furniture. The VINCENT sofa is everything that you need at home!

VINCENT, 3 seater, Luis 5 light brown

>>245



A new dimension of romanticism. The geometric shapes of the sofa, the gentleness of its form and the very traditional quilting of the cushions all make an extremely fashionable combination. GIORGIO is a piece of furniture for demanding customers who appreciate excellent design. To additionally accentuate the innovative presentation of the classic solutions, choose a strong colour of the upholstery.

GIORGIO - a spirit of tradition in modern form.

GIORGIO

>>215



QUATTRO

>>234



The QUATTRO collection means tens of design arrangements that can be produced by using items such as a sofa, a corner sofa, an armchair and a footstool. A distinguishing feature of this collection is an armrest designed as a convenient shelf. Using the unique models available in the collection, you can arrange sofas and corner sofas at different angles, thus producing incredible effects. Selected sofa models are also available as sofa beds. QUATTRO is a comprehensive collection with contemporary design, durable and elegant - discover all it offers.

QUATTRO - the sky is the limit.

QUATTRO, set 14 right, Matrix black

PASSION



The classic and chic family of furniture. The most important in is comfort hidden inside. The pocket springs, high resilient foam and soft top of cushions: down&feather mixed with fiberwool balls guarantee absolutely the highest level of comfort. PASSION is the first model in SITS collection made with RICH comfort! Moreover premium comfort guarantee the high level of use, also for allergics.

>>232

VARIO

What do you expect from furniture that belongs to HOME & FAMILY category? That it will be a solution for an intensive family life. VARIO fulfills this expectations because of its well-balanced shapes, that will fit to many interiors and lot of solutions that can be chosen. Option of quilting can give VARIO unique relish. Modular system gives unlimited possibilities of arrangements, also with sofa bed. Two types of comfort (standard and lux) to be chosen.

designed by Ian Archer

VARIO quilted, 3 seater, Caleido 3790 light beige

>>239



ANTARES

Simplicity combined with durability and robustness make ANTARES an extremely practical piece of furniture. It will suit any interior, and the choice of options with removable covers makes this piece of furniture even more adaptive. ANTARES can also come with a fixed cover or in genuine leather. The collection consists of sofa beds (available in two widths), as well as many items for your own design experience.

ANTARES, 3,5 seater, Caleido 3790 light beige

>>212

CIRCLE



CIRCLE will enchant you with its simplicity. It is a perfectly shaped and sized pouffe. Whether it will suit your interior or not is up to you, as you can choose from the SITS collection of tens of fabrics. CIRCLE is a comfortable seat, but can also be used as a sophisticated decorative feature.

CIRCLE - design all around.

>>213



NEPPI

NEPPI - a pouffe shaped like a cube. It is difficult to find a simpler but equally attractive way to eliminate the problem of insufficient sitting space in your home. This well-shaped and ideally-sized pouffe is available in many colours and designs that will give a completely new look to your interior.
NEPPI - a concentration of colour.

NEPPI,
footstool, Panno 2036 orange
footstool, Brest 67 natur

>>231

MYNTA

The parting sides gently blending with the backrest give the body of this piece of furniture its beautiful shape. Its delicate, high feet provide the ideal balance. MYNTA offers a style that will be appreciated by mature people with a perfectly sophisticated taste. With these people in mind, we focused on features that make the furniture even more comfortable - the well-thought-out height of the seat and the availability of upper sections as headrests. All this makes MYNTA the ideal choice for people with a mature taste.
MYNTA - the mature style.

designed by Niels Gammelgaard

MYNTA,
set 5 left, Brest 67 natur

>>230





MILANO

Simplicity and comfort are only two of the many advantages of MILANO. The design of the items in this furniture collection is truly modern, and much attention was given to make it very comfortable and easy to use. The MILANO family is very large. It includes items that can be freely arranged to create a friendly and modern atmosphere in any interior.

MILANO, set 1 right, Acker 7 mustard

>>228



KORIANDER

>>221

KORIANDER - created for mature users. KORIANDER has a large seat, and the unique softness of its cushions is the result of using special silicone balls instead of traditional feathers. KORIANDER is the ideal choice for people with a mature sense of style - this piece of furniture is a sophisticated combination of curved features with the simplicity of the cushions.

KORIANDER, set 1 right, Nilo 32 grey

KORIANDER - the strengths of maturity.

designed by Ian Archer



KALLE

Stylish and elegant. The shape of this item, together with parts such as armrests and cushions, make KALLE a representative of the modern style in furniture design. Still, the sofa has some traditional features redesigned to keep up with the times. Thanks to the successful combination of the old and the new, you can admire the simplicity of the shape of the sofa, its high and slender feet and its extremely decorative cushions with quilting that harks back to the traditional style in furniture making.

KALLE - the king of quilting.

KALLE, 3 seater, Classic Velvet 3 brown

>>218



LOTTA



LOTTA from HOME & FAMILY is a smart 3 seater sofa bed. It has a mechanism that can work as a separate sofa bed or can be connected with the main part of furniture to create comfortable space to sleep for two people. Two solutions helps in keeping LOTTA clean for a longer time: loose cover and special pad protected matters.

LOTTA, 3 seater sofa bed, Caleido 1419 natur

>>223



PUK - a sofa bed. It has been so designed as to ensure that unfolding it takes as little space as possible. PUK will be the ideal choice for a small interior. Its simple form will also make a good match with a modern interior decor. PUK is a very practical and highly adaptive sofa.

PUK - a small great sofa.

designed by Niels Gammelgaard

>>234



LUKAS

LUKAS - a collection of sofa beds. LUKAS is a sofa bed that comes with the-only-in-its-kind mechanism for converting the sofa into a bed. It is comfortable and easy to use - the bed frame and the mattress are hidden inside the sofa all the time. All it takes to unfold it is three simple moves. During the day, LUKAS will serve as a robust and comfortable sofa. What's more, you can change the way it looks - by choosing one of three types of armrests.

LUKAS - what counts is the interior.

LUKAS, set 1 right, Bona A373 beige

>>223





BARI

BARI is a nice looking sofa with a sleeping option. All elements used are to highlight the simplicity of its form: well-shaped cushions, seats and backrests as well as ideally-profiled legs. The BARI sleeping option is simplified to maximum, the unfolding mechanism does not require much strength. The furniture is equipped with a bedding container as standard, it is supplied with a blanket to protect the upholstery fabric against damage when you sleep.

BARI, 3 seater sofa bed, Cedros 3 light brown

>>213



There is furniture which, like people, fragrances or landscapes, make you feel of your home. It is also GRETA - elegant, but also durable and amazingly comfortable. There is something in the gentle curves of its backrest, in its beautiful wooden legs and in its comfort (ensured by an extra cushion) that will make you choose GRETA once you enter the room where it stands. GRETA - welcome home!

GRETA, armchair, Panno 2240 turquoise

>>215

GRETA

HUMPHREY

A successful mixture of the classic and the romantic that gives the armchair its shape. The item's robust shape and gentle features have been combined in ideal proportions to create a piece of furniture that will arouse emotions.

HUMPHREY - an armchair with character!

HUMPHREY, armchair, Panno 1000 light grey

>>217



WATSON

WATSON - an armchair you will fall in love with. The shape of the armchair and its features - or, to put it briefly, all the parts of this piece of furniture - have been designed with the user's comfort in mind, with elements of the romantic style of gentleness and harmony.

WATSON - the beginning of a long-lasting friendship.

WATSON, armchair, Himalaya 7 green

>>245





VENEZIA

VENEZIA - an upholstered chair with perfect proportions. The cubic shape of the seat will enchant you with its simplicity, while the gentle, slim legs give this piece of furniture its subtlety and balanced shape. VENEZIA is the quintessence of elegance and clearly defined style. VENEZIA - a unique style.

VENEZIA, chair, Zen 3 black-white

>>245

VIGGO

An upholstered seat and wooden frame - this is our VIGGO chair. A simply, everyday chair for any space. VIGGO is the base for any interior with unlimited choice of fabric or leather. If you want to add energy to your space, mix different colors of chairs.

VIGGO,
chair, Dover 5 dark turquoise
chair, Dover 7 green

>>245



LINN

LINN a classic chair for the dining room with straight armrests and wooden legs. Simply, rangy and very cozy. Easy to use thanks to removable fabric covers or fixed leather covers. Simply a chair for any space in your apartment.

LINN,
chair, Caleido 3790 light beige
chair, Caleido 1419 natur
chair, Caleido 10996 grey-beige
chair, Caleido 2990 powder pink

>>222





LUNA

Simplicity, beauty, and a bit of mystery - just like the goddess of the moon - LUNA has all these features. Sleep is the time of rest, peace and pause after usually a hard day. A comfortable, beautiful bed is to guarantee us that. LUNA can be made from any fabric.

LUNA, bed, Brest 67 natur

>>225

HEBE

Sleep is health - source of youth and vitality. We called our bed HEBE - just like the Greek goddess symbolizing youth. It was HEBE who gave to the gods from Olimp the nectar of youth. Our bed has similar abilities, using it ensures indispensable energy and joy.

HEBE, bed, linen graphite

>>216



DIANA

DIANA is a bed for the people who are not satisfied with the sleeping minimalism. The warmth of fabrics with decorative elements are the components of today's glamour style without excessive exaggeration, without numerous ornaments; calm, cozy and original. The quilted and upholstered head end is its greatest feature. In case of DIANA its is quite a successful result of connecting various styles. The bed frame, though also simple, is upholstered making the DIANA warm and inviting - and thus ensuring a good nights sleep.

DIANA, bed, Zen 4 light grey

>>214



LEON

The rounded head of this bed makes it look really attractive. Thanks to its well-designed shape, LEON offers great design potential. Depending on the fabric and legs (metal or wooden) you choose for your LEON bed, you can create various design effects. LEON can be a minimalist or a classic - you choose. LEON - a specialist in style.

LEON, bed, Matrix dark grey

>>222





You close the door behind you and you feel the warmth and calmness when you enter your home after a long day. You know that this hour is just for yourself. You put on your favourite music, pour a cup of tea and snuggle up in your favourite place in the house...

The world of TEA & BOOK has everything to become a perfect place for having a rest and relaxation at home. Each product has an individual design and is characterized by the highest possible comfort from all the products in SITS collection. By entering this world we assure you that you will never want to leave the sofa again.

Comfortable Life!



*tea
& book*





designed by Dan Ihreborn

LEO, 4 seater, Sobral 09 dark grey

LEO

A comfortable, soft, big sofa with fabric made like a blanket. Its creates a classical and relaxed style. The fabric cover is specially lined with fiber and cloth. LEO is designed by Dan Ihreborn. So, grab a cup of tea and try our LEO!

>>257

SARA

The lux comfort provides great comfort and softness, with a shape which is very romantic and also elegant. The special decoration - wooden buttons on the back of sofa are very stylish details. The footstool with its secret box is the unique piece in the collection. SARA is the best choice for a friendly living room.

designed by Dan Ihreborn

SARA, 3 seater, Linen natur

>>262

JULIA

JULIA is designed by Dan Ihreborn. The family is the result of the modern romantic project, and has many possible configurations: 2 comforts: lux or premium, 2 covers: fabric or leather, 2 materials for feet: metal or wood and a lot of original shapes. It provides unlimited possibilities for sofa creation.

designed by Dan Ihreborn

JULIA,
set 1 right (without footstool), Caleido 3790 light beige
armchair, Caleido 3790 light beige

>>255



JULIA

designed by Dan Ihreborn

JULIA, 3 seater round, Aniline sand

>>255



LENA

With our LENA you can make any interior design you want. You can select between 3 sofas in 3 different versions with 2 alternative upholsteries. Add cushions with details and choose LENA with deep version or standard version. LENA - amazing sofa in any arrangement you need.

designed by Dan Ihreborn

LENA, 2 seater ver.A, Linen L616 0003 sand

>>256





Main qualities of LILY are stylish looks and extra-ordinary comfort. Owing to the backs which are higher than standard, the armchairs and sofas from this line ensure good support for your spine and, thus, make relax exceptionally comfortable. The padding of the seats and backs comes in two versions: Standard and Lux. LILY is available with leather or textile cover.

>>258

designed by Ian Archer

LILY, 3 seater, Divine 50 light grey

OSCAR



The large OSCAR family welcomes you! The OSCAR collection comprises sofas, armchairs, pouffes and six types of corner sofas. The simple shape of the furniture is offset by the large number of cushions it comes with. The cushions are available in three different sizes, and their excellent sewing quality is a distinguishing feature of the collection. Each of the modules in the OSCAR furniture collection can come in a different colour and/or be made of up a different type of fabric. Design you own OSCAR!

OSCAR, arrangement, Caleido 2934 dark grey, Drom 54 grey, Bona B6B6 dark grey, Ritual 55 black, Das 55 black

>>261

ROSE

This furniture is classic and elegance because of its lines that refers to British clubs for gentleman. On the other hand it is also contemporary and fresh thanks to the introduction of metal legs to the design. ROSE is available in two versions: Standard and Lux, with textile or leather cover.

designed by Ian Archer

ROSE, 4 seater, Messina 3 dark grey

>>262



COLORADO



>>253

COLORADO will let you appreciate the benefits of a large family. COLORADO is big, comfortable and modern, and the units in this collection are designed to seat many people. With the large seats and many cushions, COLORADO will give all your family maximum comfort during family celebrations. The COLORADO family is also impressive - it includes armchairs, sofas and corner sofas available in various sizes and arrangements.

COLORADO - family celebrations every day.

COLORADO, 4 seater, Caleido 1420 white



BRANDON

BRANDON - a combination of comfort and simplicity supported with modernity. The simple shape of BRANDON is the starting point - depending on the area of your room and your needs, you can choose the basic model that will serve as a comfortable and elegant piece of furniture. But you can also go a step further and choose from a few types of corner items or use a specially designed module that will create a gentle curve and produce attractive, aesthetically pleasing and practical solutions.

BRANDON - practically beautiful.

CLOUD

CLOUD features a compact and regular shape. It is elegantly upholstered with decorative side frills, and it is incredibly comfortable. The perfect combination of its different parts - the height of the armrests and the softness of the cushions - will give you maximum comfort. CLOUD is your private cloud for excellent relaxation.

CLOUD - a piece of the sky.

CLOUD, 3 seater, Caleido 3790 light beige

>>252





The simple lines of this sofa are an expression of peace and harmony. Each part of ALASKA is truly comfortable. The wide surfaces of the seats and the gently bent tops of the backrests and the soft cushions create a quiet and gentle landscape. ALASKA is your refuge - a land of peace, a place outside this world. The ALASKA family consists of many items - corner sofas, sofas, armchairs - for you to create your own oasis of peace.

ALASKA - your oasis of peace.

ALASKA, set 3 left, Ritual 99 white

>>249



ALASKA

ABBE

Simple in form but very comfortable sofa. The special sewing of cushions gives a unique form to the furniture as whole. ABBE provides you with the best possible comfort along with the fabrics from collection you can have the great living room companion.

ABBE, set 6 right, Roma 63 grey



>>248

NEW YORK

NEW YORK is a city that never sleeps. For many people, the city is the world's centre of cultural and social life. This vision inspired our designers to create a sofa that will be the focal point of any interior. With its large size and deep seats, NEW YORK is the best place for getting together with your friends. The cushions that come with the sofa are so soft because they are filled with feathers. Additional support for your back is provided by lumbar cushions filled with foam and feathers. With removable covers, you will be able to enjoy using the sofa for many years. The NEW YORK collection consists of a three-seat sofa, a two-seat sofa and a pouffe.

NEW YORK, 4 seater XL, footstool, Caleido 3790 light beige

LINDA

Multi-element collection. All parts can be easily composed or divided, and each can be used as a separate piece of furniture. LINDA's simplicity gives it discreet elegance. Its uniquely large seats filled with silicone balls can be used by allergic people. It is so soft that everyone, with no exceptions, will enjoy using it.
LINDA - the solution to changing moods

LINDA, arrangement, Linen natur

>>258



Using HEAVEN furniture everyone is bound to feel like in heaven. Fans of perfect relaxation have a wide offer of elements to choose from: sofas, armchairs, pouffes and 8 corner settees. In the HEAVEN collection comfort is of utmost importance. It is easy to use thanks to the removable covering. Additionally a lumber cushion is provided, the seat cushions and backrest is filled with down.

HEAVEN, set 6, Linen Loo7 natur

>>254



HEAVEN



KAJSA

The lines of this piece of furniture were accentuated with decorative stitching along the edges of the armchair. This reveals the full beauty of its shape, which makes you think of a calyx or a pair of hands folded like a calyx. While sitting in the armchair, you will feel surrounded by comfort. KAJSA looks the most beautiful when made of velvet or chenille fabrics.

KAJSA - surrounded by comfort.

designed by Ian Archer

>>256



MIA

MIA - stability, comfort and simplicity. MIA is an armchair with a semi-circular shape that looks like a horseshoe - a symbol of luck.

Thanks to its removable cover, you will be able to keep this 'luck' in your home for many years.

MIA - for years, for luck.

MIA, armchair, Linen Loo7 natur

>>260



FATTY

The big family of Scandinavian style footstools designed by Anna Näsström. Any size you want, small or large, circular or square versions. We present 3 options of footstool: uniform, double trouble or flavours. The comfort is surprising. There are no words to describe it. This unique footstool perfectly matches other furniture. Choose any size you want in loose cover and enjoy!

>>254

designed by Anna Näsström





cocktail & design

Agda

>page 24

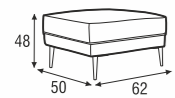

footstool 62x50

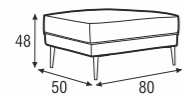

footstool 80x50

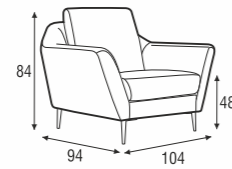

armchair

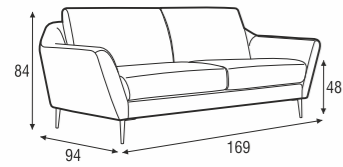

2 seater

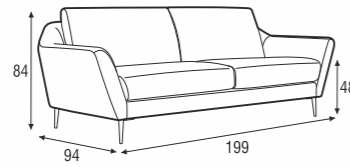

2,5 seater

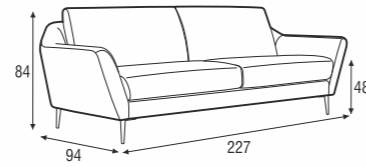

3 seater

Alex

>page 74

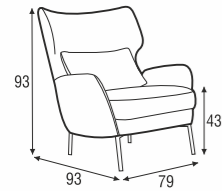

armchair

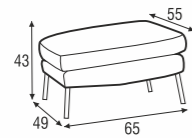

footstool

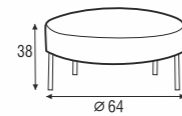

footstool round

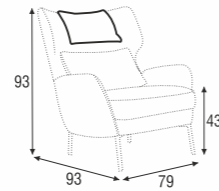

headrest

Available in fabric or leather.

Allan

>page 48

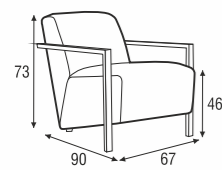

armchair

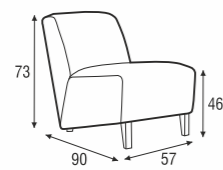

armchair without armrests

Alma

>page 66

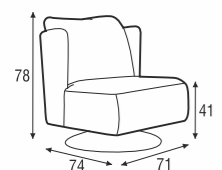

armchair swivel
without buttons

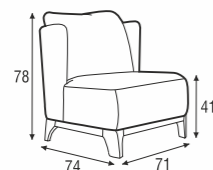

armchair
without buttons

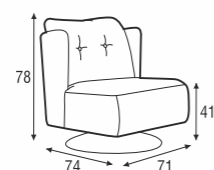

armchair swivel
with buttons

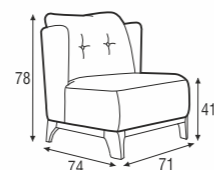

armchair
with buttons

Available in fabric or leather.

Caprice

>page 42

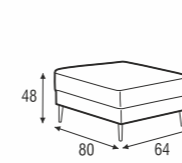

footstool

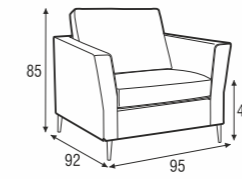

armchair

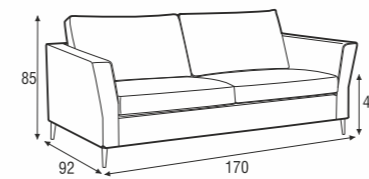

2 seater

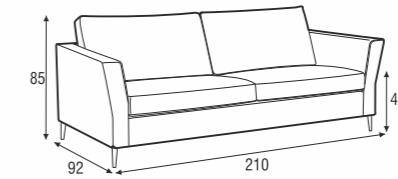

3 seater

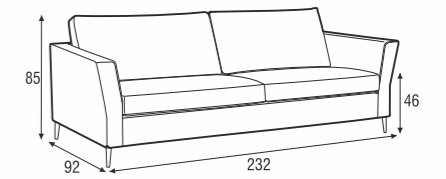

3,5 seater

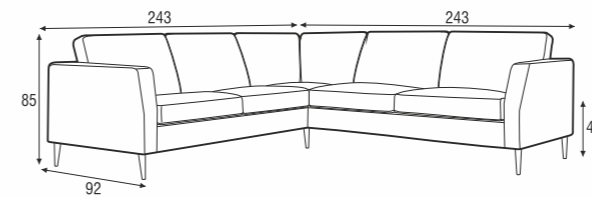

set 1

2 seater left + corner 90° + 2 seater right

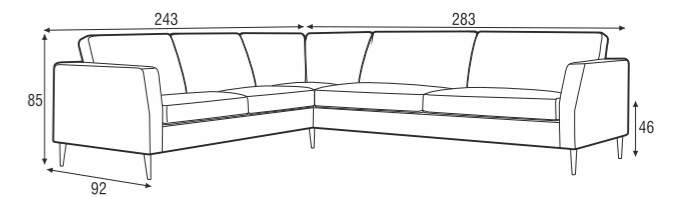

set 2 left / or right

2 seater left / or right + corner 90° + 3 seater right / or left

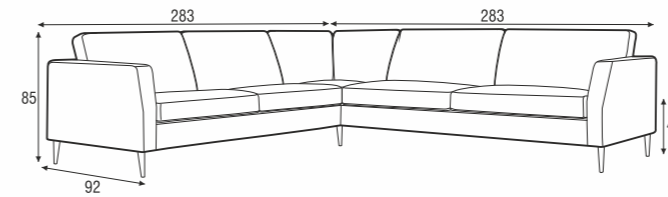

set 3

3 seater left + corner 90° + 3 seater right

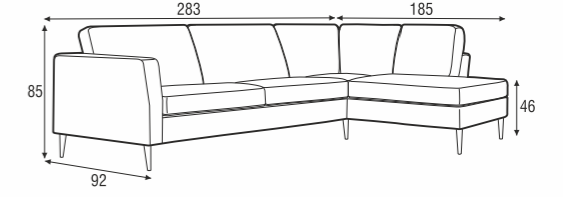

set 4 right / or left

3 seater left / or right + divan right / or left

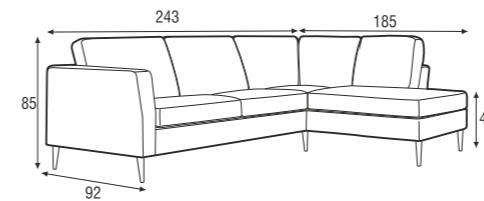

set 5 right / or left

2 seater left or right + divan right / or left

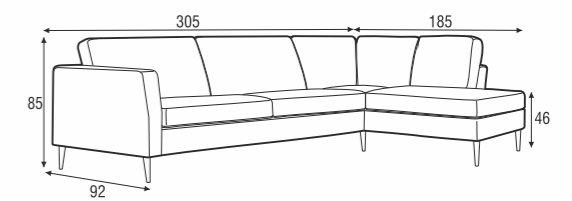

set 6 right / or left

3,5 seater left / or right + divan right / or left

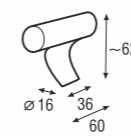

headrest with roll

Clark

>page 62

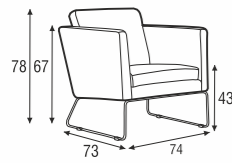

armchair low

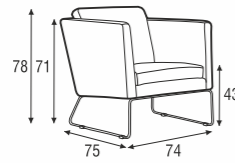

armchair

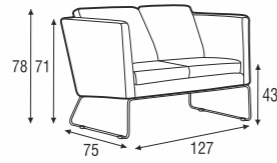

2 seater

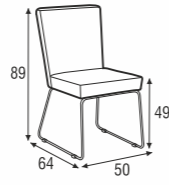

chair without armrests

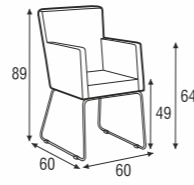

chair with armrests

Available in fabric or leather.

Cubic

>page 34

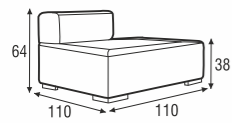

element small

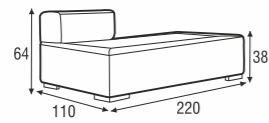

element big

Unlimited possibilities of combinations:

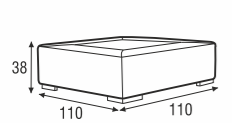

110x110 cm

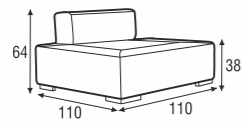

110x110 cm

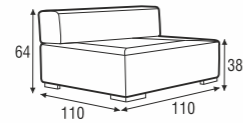

110x110 cm

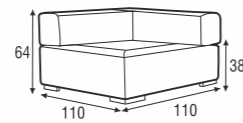

110x110 cm

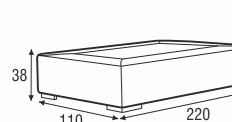

220x110 cm

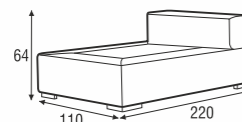

220x110 cm

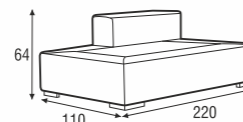

220x110 cm

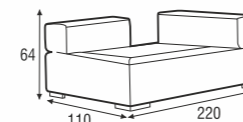

220x110 cm

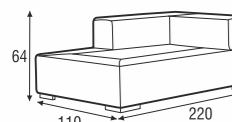

220x110 cm



220x110 cm



220x110 cm

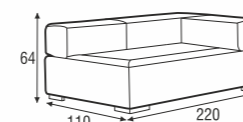

220x110 cm

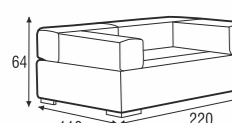

220x110 cm



220x110 cm

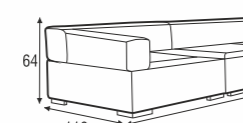

330x110 cm

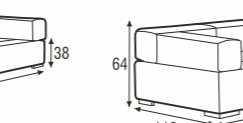

440x110 cm

>>cubic

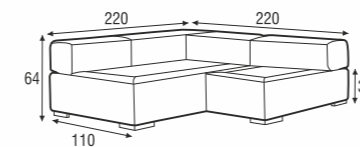

220x220 cm

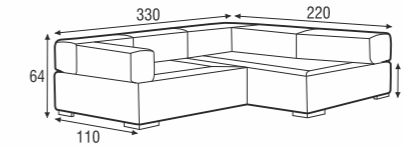

330x220 cm

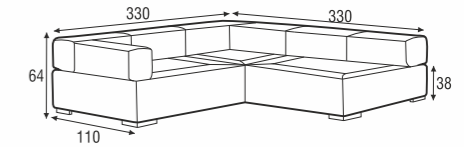

330x330 cm

armrests

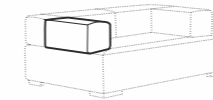

armrest / backrest no.60

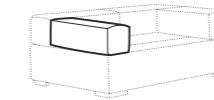
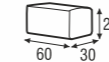

armrest / backrest no.80

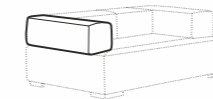
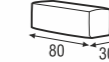

armrest / backrest no.110



cushions

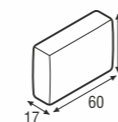

back cushion
60x42

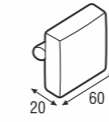

back cushion
with roll 60x57

Donna

>page 70



footstool

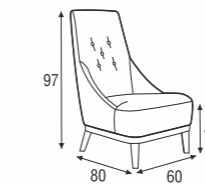

armchair

Doris

>page 22

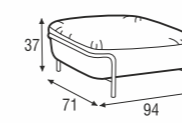

footstool

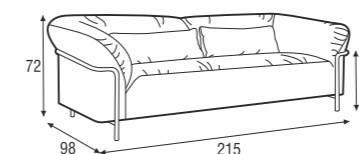

2 seater

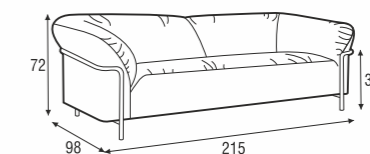

2 seater without back cushions

>>doris

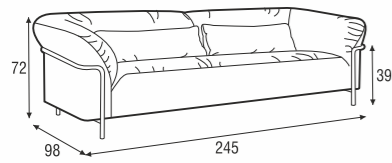

3 seater

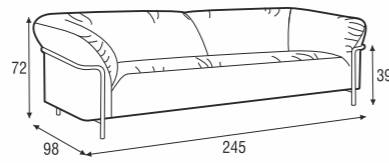

3 seater without back cushions

cushions

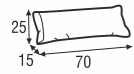

cushion 70x25
2x 2 seater

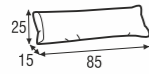

cushion 85x25
2x 3 seater

Elsa

>page 50

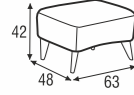

footstool

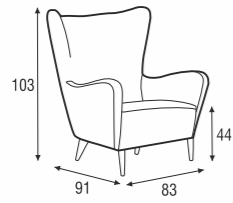

armchair

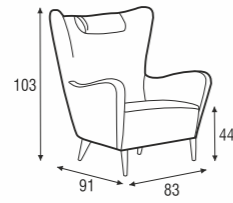

armchair with neckrest pillow

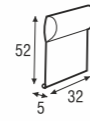

neckrest pillow



Limited choice of fabrics. Check with sales staff.

Foxi

>page 60

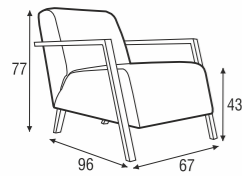

armchair

Available in fabric or leather.



Ginevra

>page 58

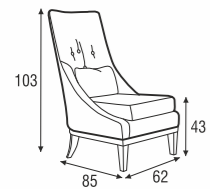

armchair



Hugo

>page 8

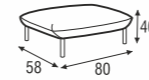

footstool

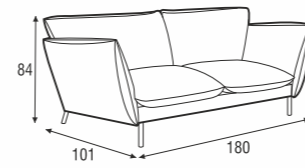

2 seater

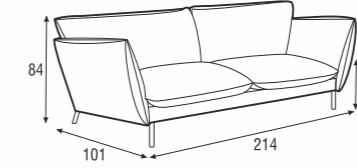

3 seater

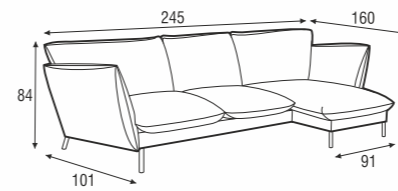

set 1 right / or left
2 seater left / or right + chaiselongue right / or left

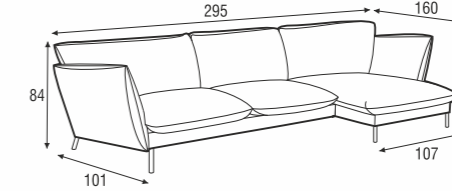

set 2 right / or left
3 seater left / or right + chaiselongue wide right / or left

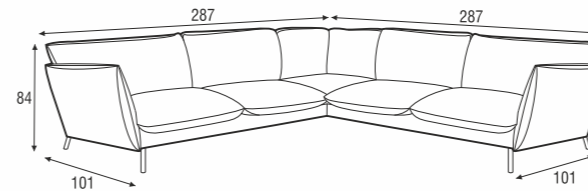

set 3
3 seater left + corner 90° + 3 seater right

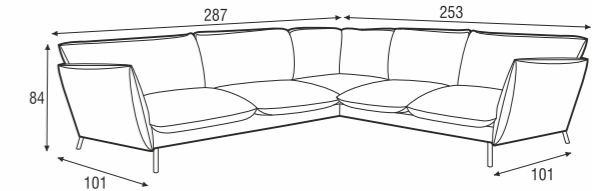

set 4 right / or left
3 seater left / or right + corner 90° + 2 seater right / or left

Available in fabric or leather.

Impulse

>page 32

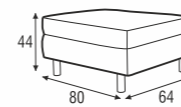

footstool

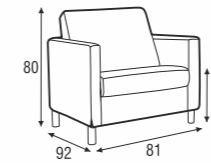

armchair

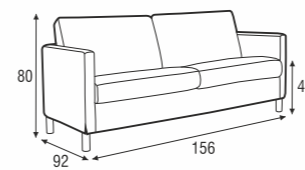

2 seater

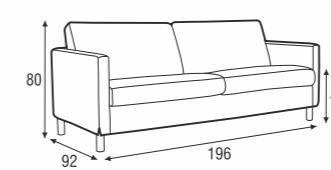

2,5 seater

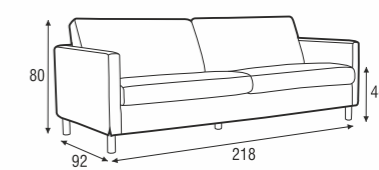

3 seater



>>impulse

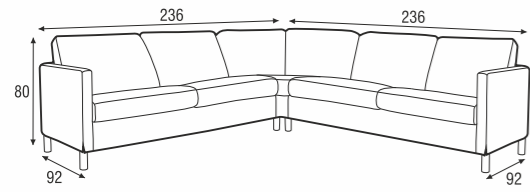

set 1
2 seater left + corner 90° + 2 seater right

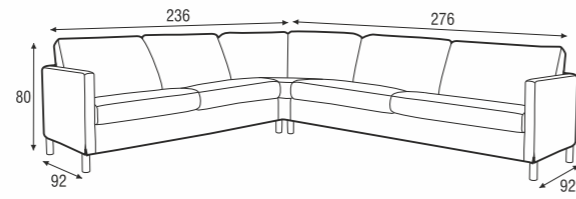

set 2 right / or left
2 seater left / or right + corner 90° + 2,5 seater right / or left

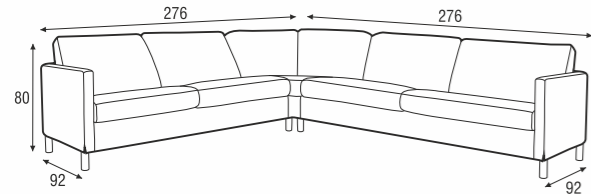

set 3
2,5 seater left + corner 90° + 2,5 seater right

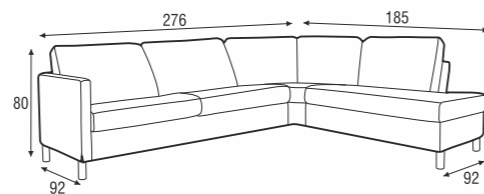

set 4 right / or left
2,5 seater left / or right + divan right / or left

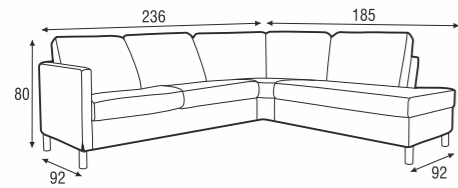

set 5 right / or left
2 seater left / or right + divan right / or left

armrests

Drawings show combinations with armrest I.
Combinations with armrest II are properly longer in width.

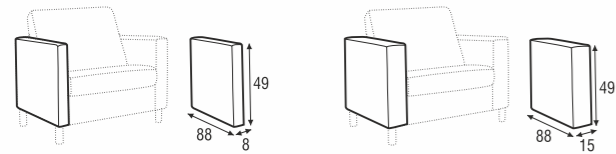

armrest I armrest II

Available in fabric or leather.

armrests cushion

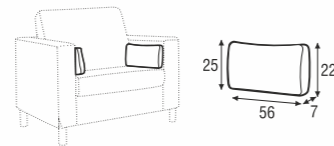

available:

3 different comforts
2 different covers;
fix or loose
2 different armrests

Ivy

>page 14

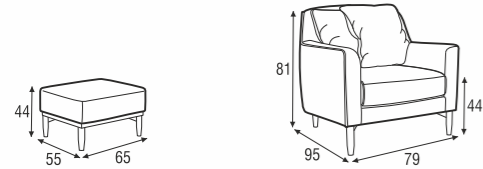

footstool armchair



>>ivy

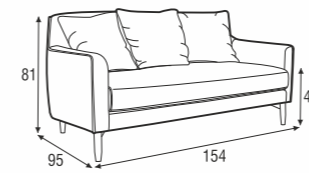

2 seater

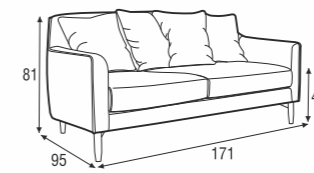

2,5 seater

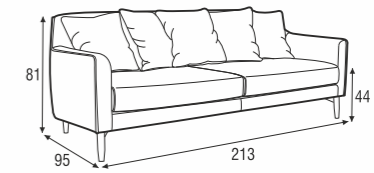

3 seater

Justus

>page 30

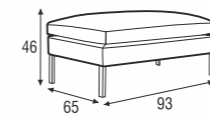

footstool 93x65

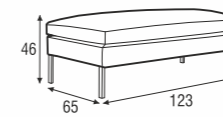

footstool 123x65

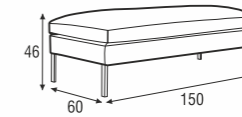

footstool 150x60

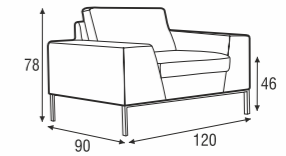

armchair

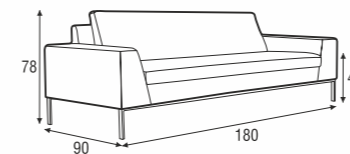

2 seater

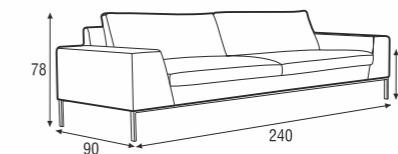

3 seater

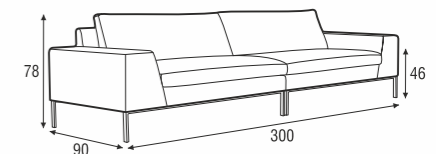

4 seater / two parts

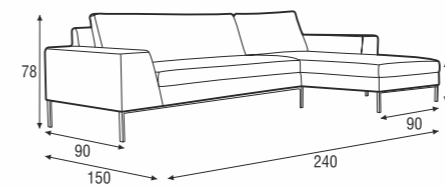

set 1 right / or left

2 seater left / or right + chaiseloungue right / or left

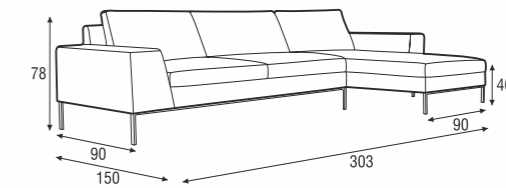

set 2 right / or left

3 seater left / or right + chaiseloungue right / or left

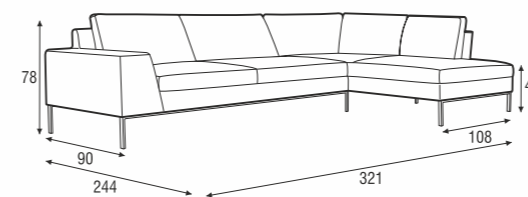

set 3 right / or left

3 seater left / or right + divan right / or left

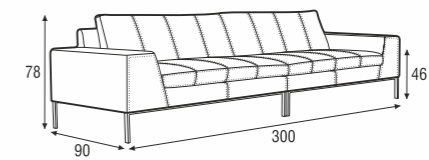

4 seater / two parts

leather cover

Available in fabric or leather.

Kato

>page 68

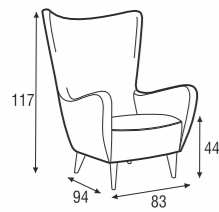

armchair

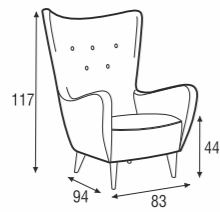

armchair with buttons

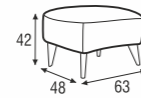

footstool

Limited choice of fabrics. Check with sales staff.

Liam

>page 26

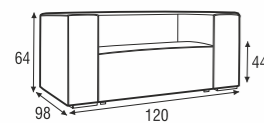

element 80

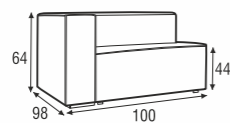

element 80 left / or right = corner 90

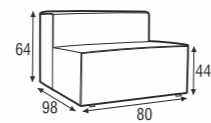

element 80 without armrest

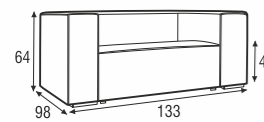

element 93

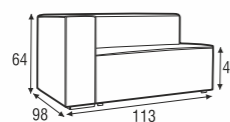

element 93 left / or right

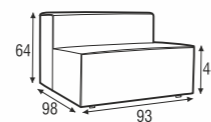

element 93 without armrest

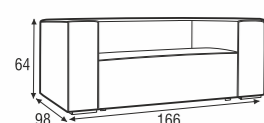

element 126

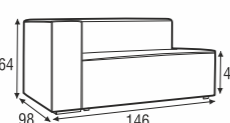

element 126 left / or right

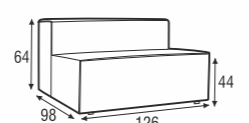

element 126 without armrest

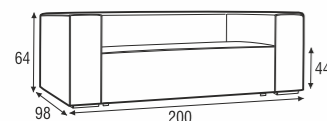

2,5 seater

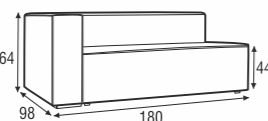

2,5 seater left / or right

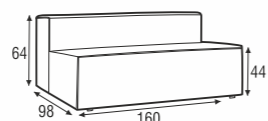

2,5 seater without armrest

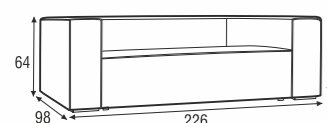

3 seater

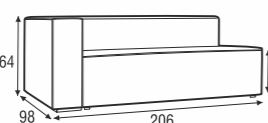

3 seater left / or right

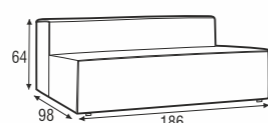

3 seater without armrest

>liam

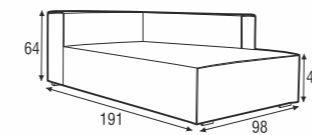

divan right / or left

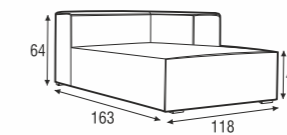

chaiselongue right / or left

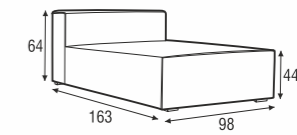

chaiselongue without armrest

Unlimited possibilities of combinations, below example arrangements.

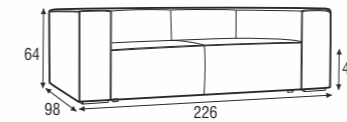

set 1

element 93 left + element 93 right

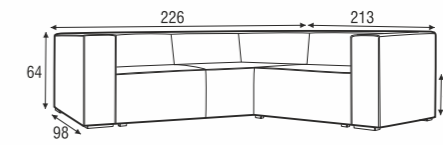

set 2

element 93 left + 2x element 93 right

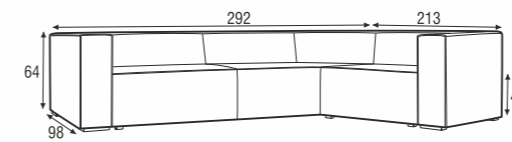

set 3

element 126 left + element 126 right + element 93 right

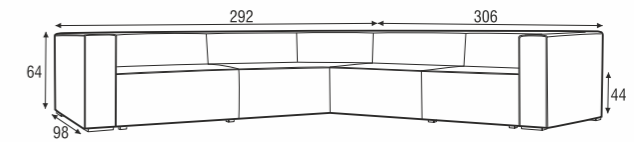

set 4

element 126 left + element 126 right + element 93 without armrest + element 93 right

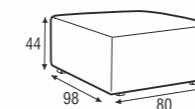

footstool 80x98

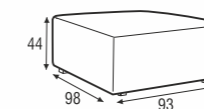

footstool 93x98

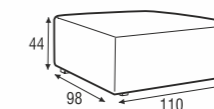

footstool 110x98

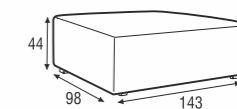

footstool 143x98

cushions

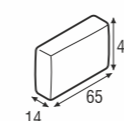

back cushion
65x42

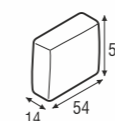

back cushion
54x54

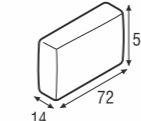

back cushion
72x54

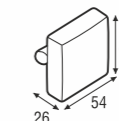

back cushion
with roll 54x62

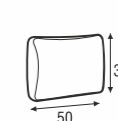

cushion
50x32

Cushions must be ordered separately.

Linus

>page 20

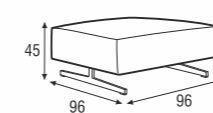

footstool

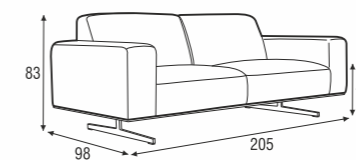

2 seater

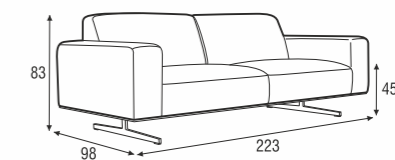

3 seater

>>linus

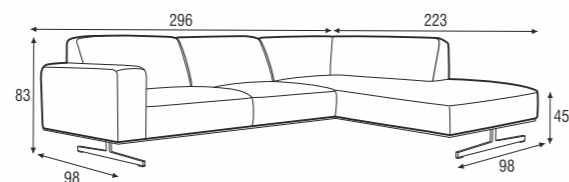
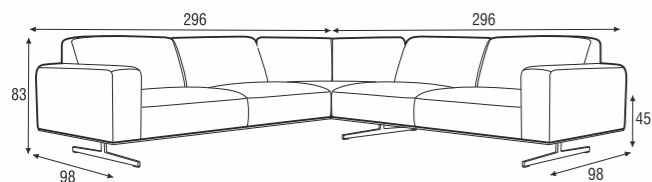

set 1
3 seater left + corner + 3 seater right

set 2 right / or left
divan right / or left + 3 seater left / or right

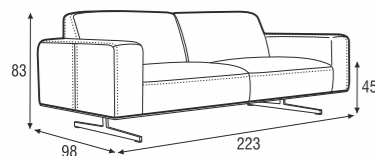

3 seater
leather cover

EXAMPLE

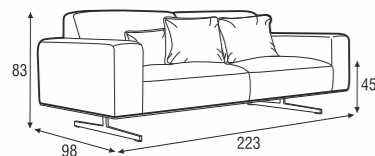

3 seater with back cushions

Available in fabric or leather.

cushions

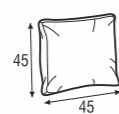

back cushion
45x45

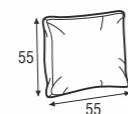

back cushion
55x55

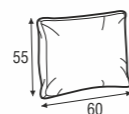

back cushion
60x55

Lisa

>page 64

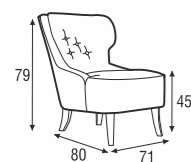

armchair
4 buttons

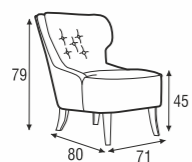

armchair
5 buttons



Ludvig

>page 40

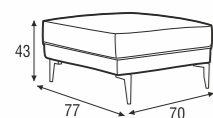

footstool

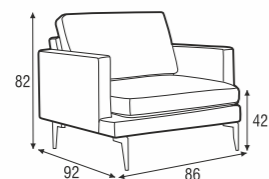

armchair

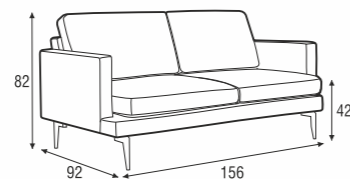

2 seater



>>ludvig

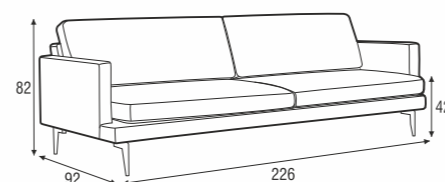

3 seater (2 cushions)

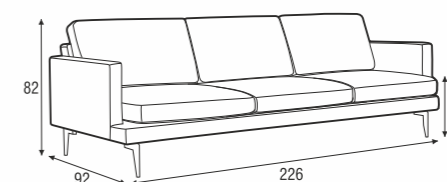

3 seater (3 cushions)

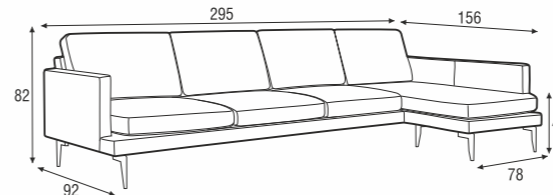

set 1 right / or left
3 seater (3 cushions) left / or right + chaiselongue right / or left

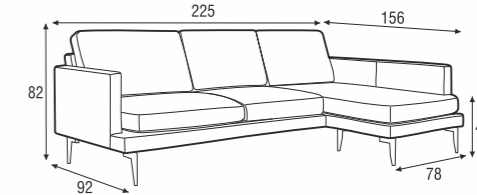

set 2 right / or left
2 seater left / or right + chaiselongue right / or left

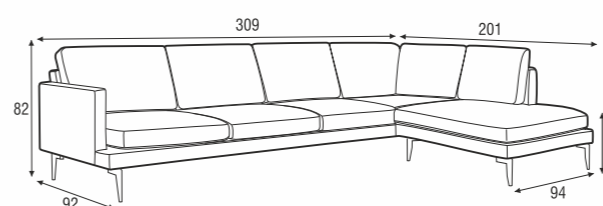

set 3 right / or left
3 seater (3 cushions) left / or right + divan right / or left

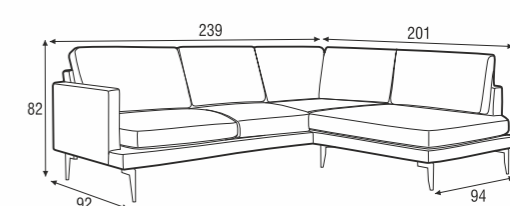

set 4 right / or left
2 seater left / or right + divan right / or left

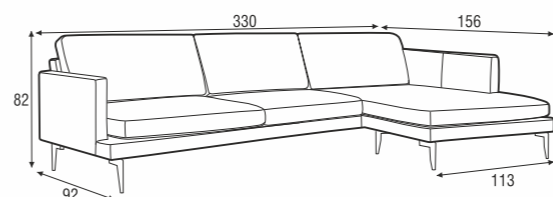

set 5 right / or left
3 seater (2 cushions) left / or right + chaiselongue wide right / or left

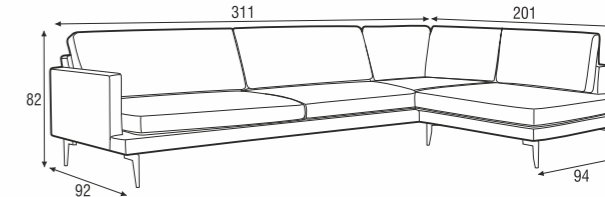

set 6 right / or left
3 seater (2 cushions) left / or right + divan right / or left

Maja

>page 10

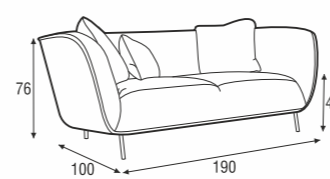

2 seater

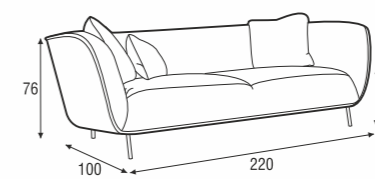

3 seater



Mattias

>page 38

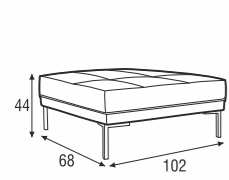

footstool

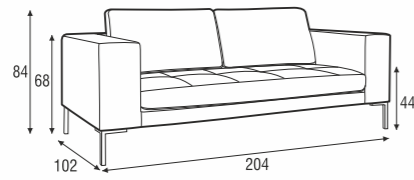

2 seater

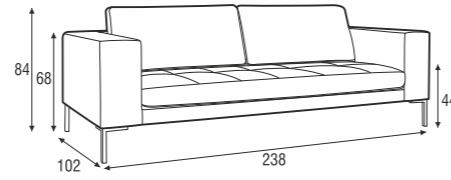

3 seater

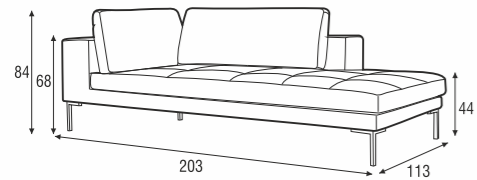

chaiselongue right / or left

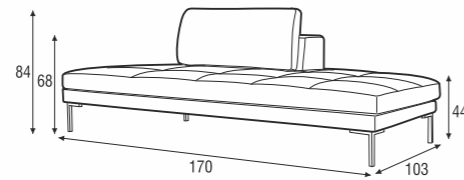

bench right / or left

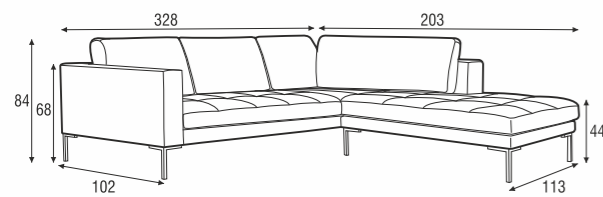

set 1 right / or left

3 seater left / or right + chaiselongue right / or left

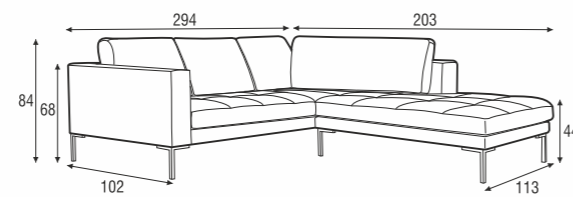

set 2 right / or left

2 seater left / or right + chaiselongue right / or left

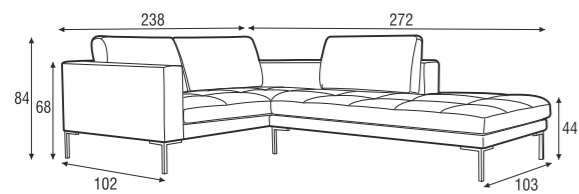

set 3 right / or left

3 seater + bench right / or left

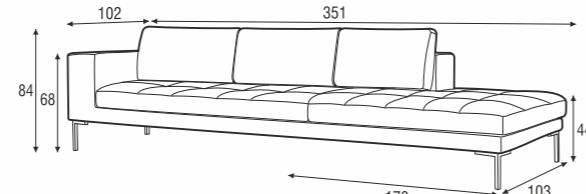

set 4 right / or left

2 seater left / or right + bench right / or left

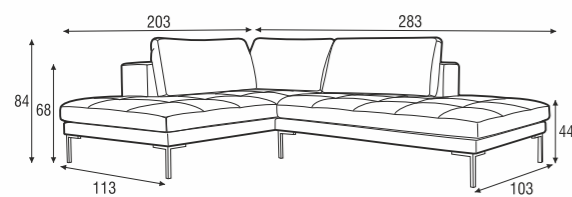

set 5 right / or left

chaiselongue right / or left + bench left / or right

>> mattias

cushions

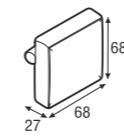

back cushion with roll 68x68

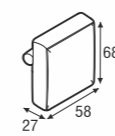

back cushion with roll 58x68

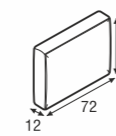

back cushion 72x54

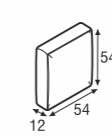

back cushion 54x54

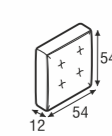

back cushion 54x54 dibble



cushion 50x30

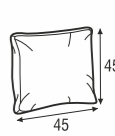

cushion 45x45

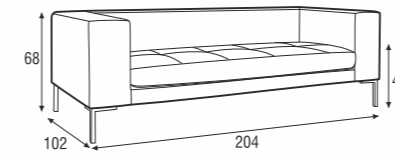

2 seater without cushions

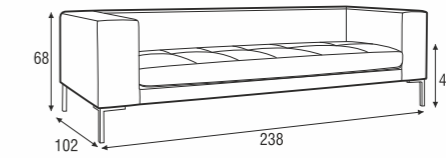

3 seater without cushions

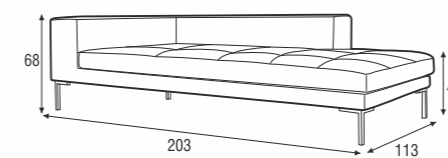

chaiselongue without cushions right / or left

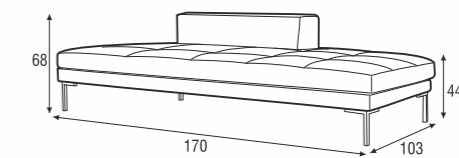

bench without cushions right / or left



set 1 without cushions right / or left

3 seater left / or right + chaiselongue right / or left

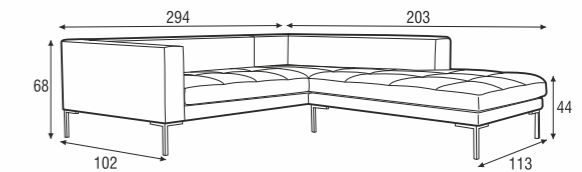

set 2 without cushions right / or left

2 seater left / or right + chaiselongue right / or left

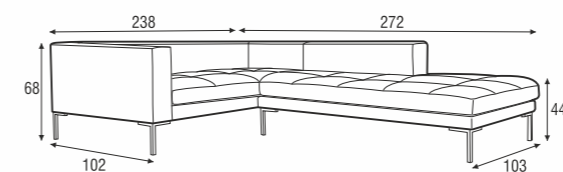

set 3 without cushions right / or left

3 seater + bench right / or left

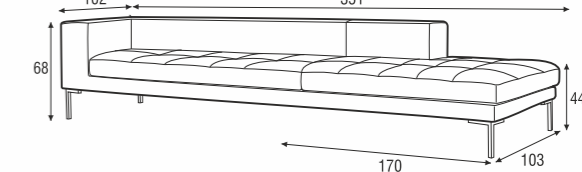

set 4 without cushions right / or left

2 seater left / or right + bench right / or left

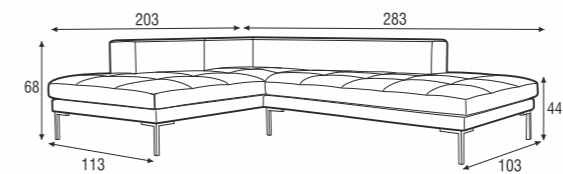

set 5 without cushions right / or left

chaiselongue right / or left + bench left / or right

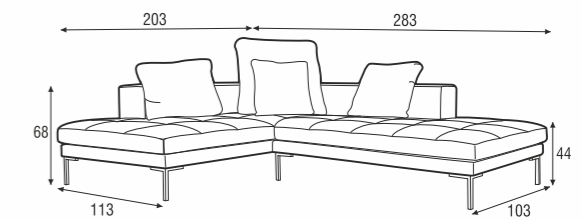

example with cushions

chaiselongue right / or left + bench left / or right + 2x back cushions 54x54 + back cushions whit roll 58x68 + back cushion 72x54

Max

>page 72

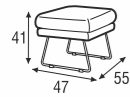

footstool

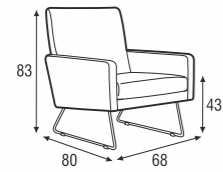

armchair

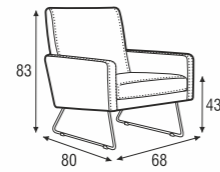

armchair
leather cover

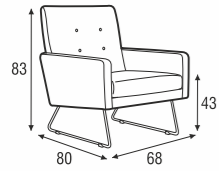

armchair with buttons

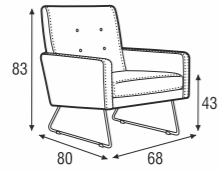

armchair with buttons
leather cover

Available in fabric or leather.

Mokka

>page 52

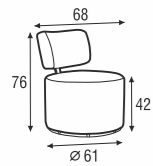

armchair espresso
swivel

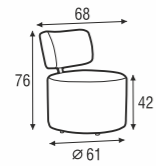

armchair espresso

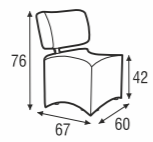

armchair cream

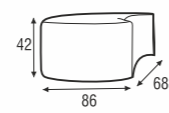

footstool cacao

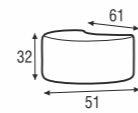

footstool vanilia

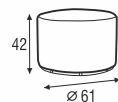

footstool sugar
swivel

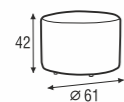

footstool sugar

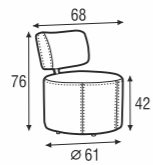

armchair espresso
leather cover

Available in fabric or leather.

Nina

>page 56

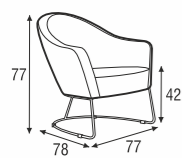

armchair

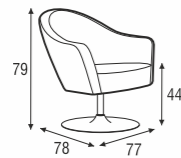

armchair swivel

Available in fabric or leather.



Ohio

>page 28

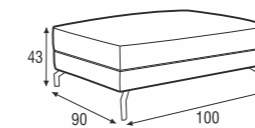

footstool 100x90

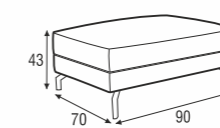

footstool 90x70

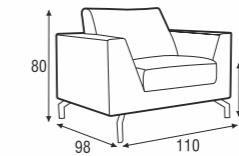

armchair

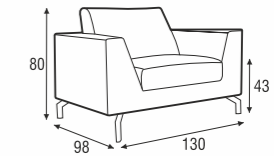

armchair wide



2 seater

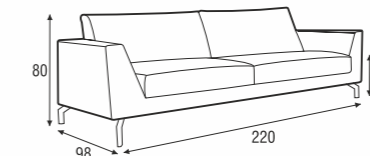

3 seater

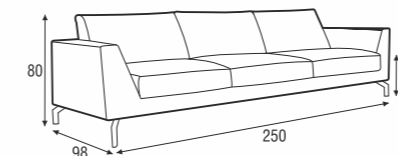

3XL seater

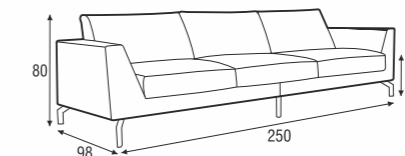

3XL seater (two parts)

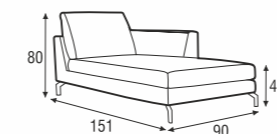

chaiselongue right / or left

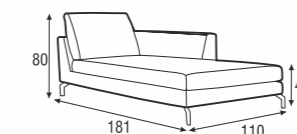

chaiselongue long right / or left

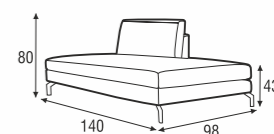

bench right / or left

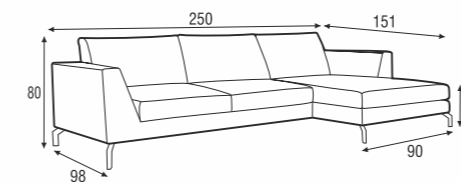

set 1 right / or left

2 seater left / or right + chaiselongue right / or left

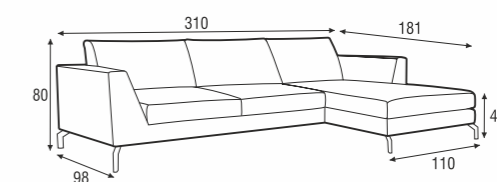

set 2 right / or left

3 seater left / or right + chaiselongue long right / or left

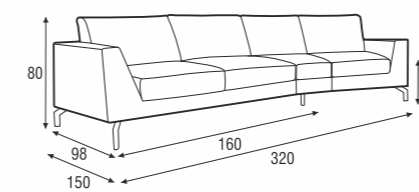

set 3 right / or left

2 seater left / or right + corner 30° + armchair right / or left

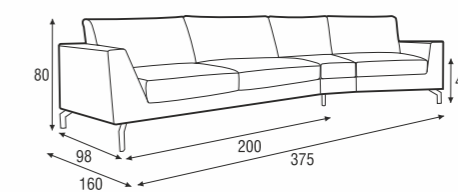

set 4 right / or left

3 seater right / or left + corner 30° + armchair wide left / or right



>>ohio

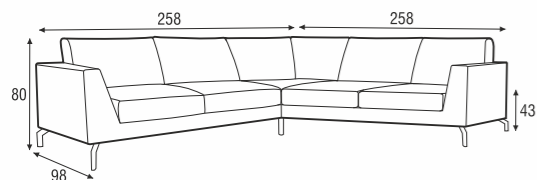

set 5
2 seater left + corner 90° + 2 seater right

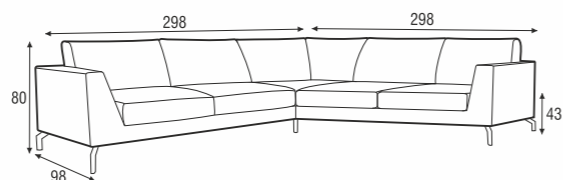

set 6
3 seater left + corner 90° + 3 seater right

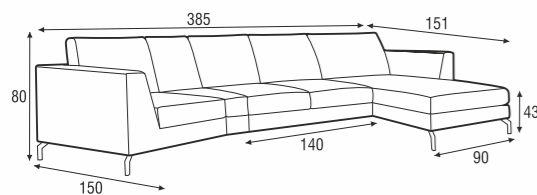

set 7 right / or left
armchair right / or left + corner 30° + 2 seater without armrest + chaiselongue right / or left

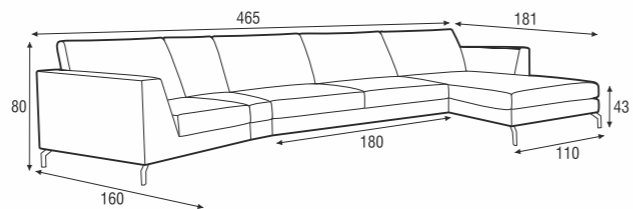

set 8 right / or left
armchair wide left / or right + corner 30° + 3 seater without armrest + chaiselongue long right / or left

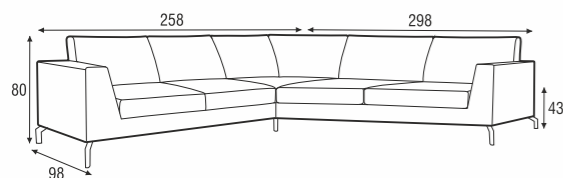

set 9 left / or right
2 seater left / or right + corner 90° + 3 seater right / or left

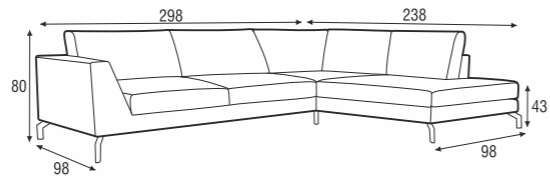

set 10 right / or left
3 seater left / or right + corner 90° + bench right / or left

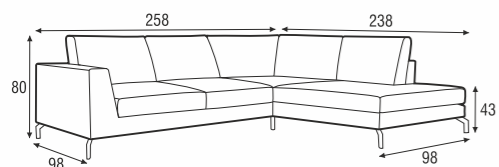

set 11 right / or left
bench right / or left + corner 90° + 2 seater left / or right

Available in fabric (standard or lux comfort) or leather (only standard comfort).

Otto

>page 16

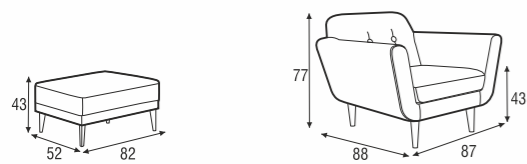

footstool armchair



>>otto

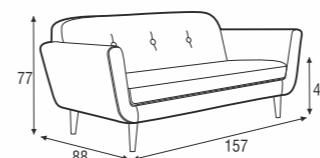

2 seater

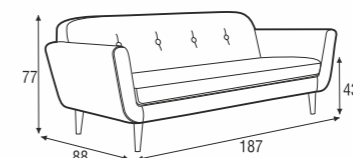

2,5 seater

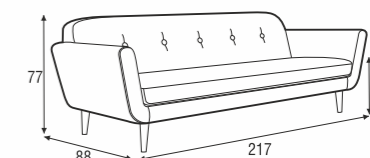

3 seater



Pola

>page 46

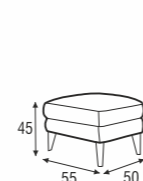

footstool

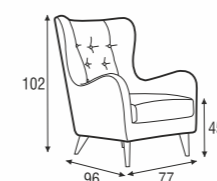

armchair

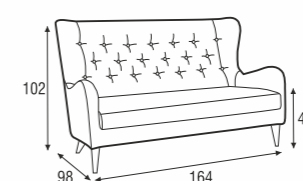

2,5 seater

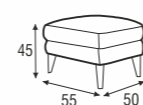

footstool
leather cover

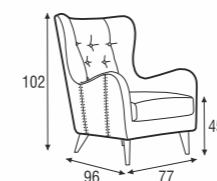

armchair
leather cover

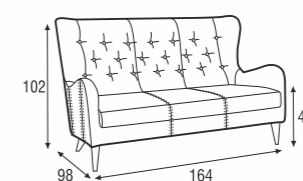

2,5 seater
leather cover

Buttons and piping available in contrast color.

Available in fabric or leather.



Poppy 1

>page 12

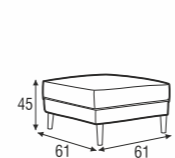

footstool

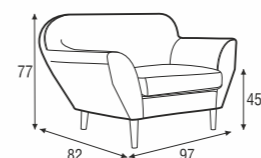

armchair

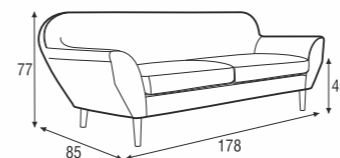

2 seater

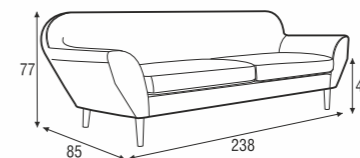

3 seater with 2 seat cushions

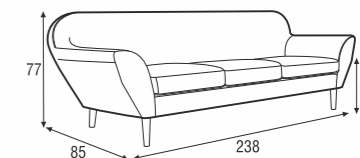

3 seater with 3 seat cushions

>>poppy 1

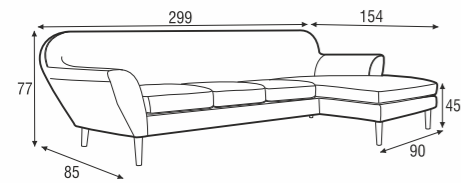

set 1 right / or left

3 seater with 3 seat cushions left / or right
+ chaiselongue right / or left

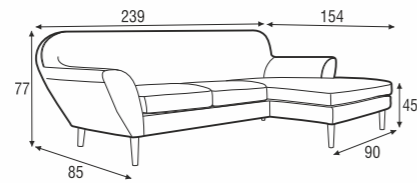

set 2 right / or left

2 seater left / or right
+ chaiselongue right / or left

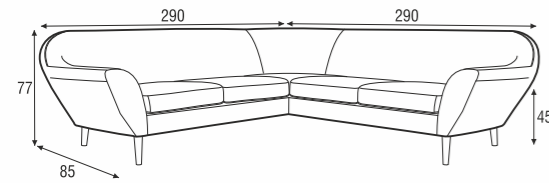

set 3

3 seater with 2 seat cushions left + corner 90°
+ 3 seater with 2 seat cushions right

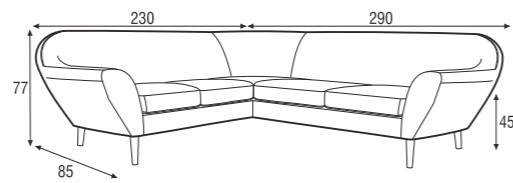

set 4 left / or right

2 seater left / or right + corner 90°
+ 3 seater with 2 seat cushions right / or left

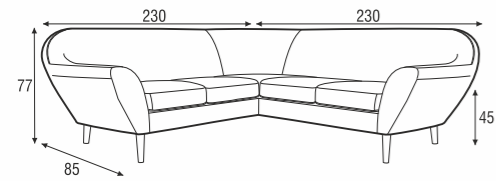

set 5

2 seater left + corner 90° + 2 seater right

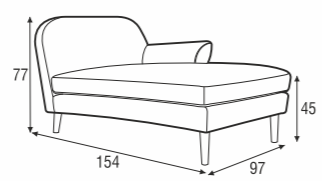

chaiselongue freestanding left / or right

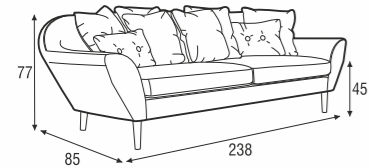

3 seater

with 2x cushions 45x30 with buttons
+ 2x cushions 45x45 with button
+ 2x cushions 40x40 + 2x cushions 45x45

cushions

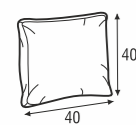

cushion
40x40

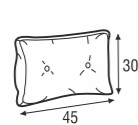

cushion 45x30
with buttons

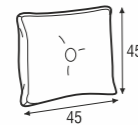

cushion 45x45
with buttons

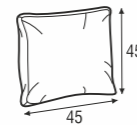

cushion
45x45

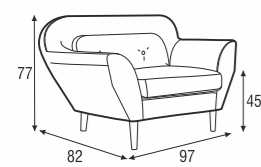

armchair

with lumbar cushion

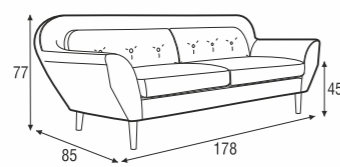

2 seater

with lumbar cushions

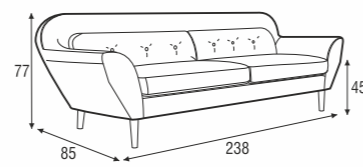

3 seater with 2 seat cushions

with lumbar cushions

>>poppy 1

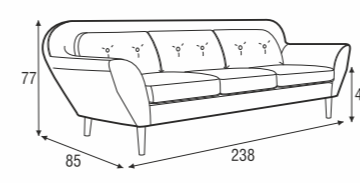

3 seater with 3 seat cushions

with lumbar cushions



chaiselongue freestanding

with lumbar cushion left / or right

suggested minimum number
of square cushions:

armchair - 2 pcs, 2 seater - 4 pcs, 3 seater - 5 pcs
chaiselongue - 2 pcs, set 1 - 7 pcs, set 2 - 6 pcs
set 3 - 11 pcs, set 4 - 10 pcs, set 5 - 9 pcs

Poppy 2

>page 12

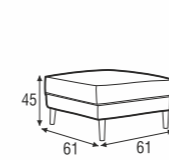

footstool

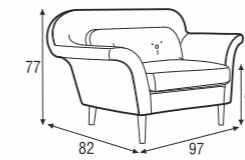

armchair

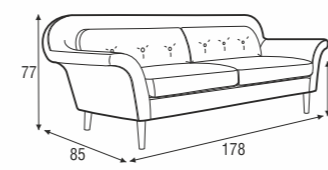

2 seater

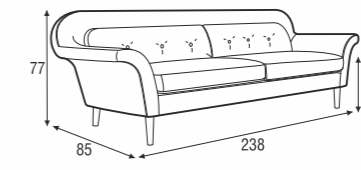

3 seater with 2 seat cushions

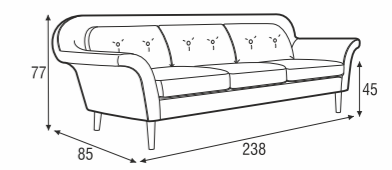

3 seater with 3 seat cushions

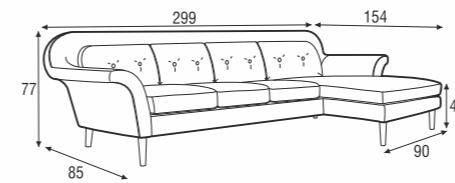

set 1 right / or left

3 seater with 3 seat cushions left / or right
+ chaiselongue right / or left

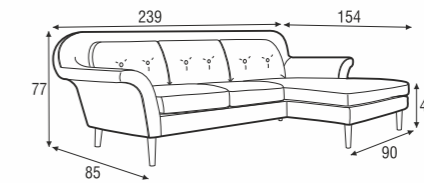

set 2 right / or left

2 seater left / or right
+ chaiselongue right / or left

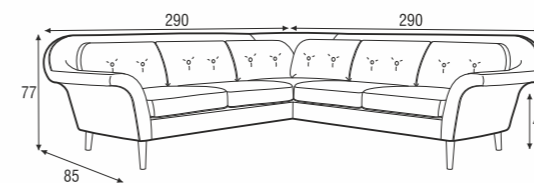

set 3

3 seater with 2 seat cushions left + corner 90°
+ 3 seater with 2 seat cushions right

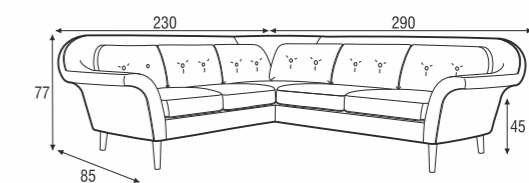

set 4 right / or left

2 seater left / or right + corner 90°
+ 3 seater with 2 seat cushions right / or left

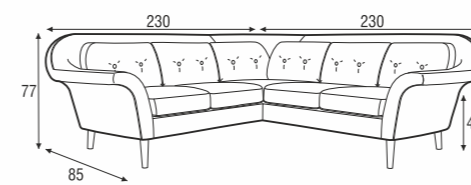

set 5

2 seater left + corner 90° + 2 seater right

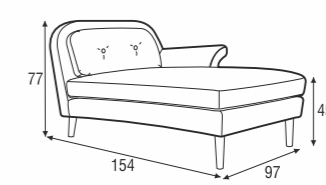

chaiselongue right / or left

>>poppy 2

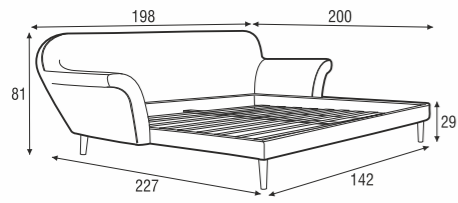

bed 140

with bonell mattress
available for mattress 140x200cm

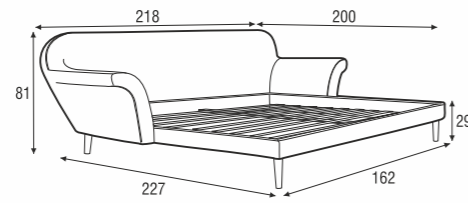

bed 160

with bonell mattress
available for mattress 160x200cm

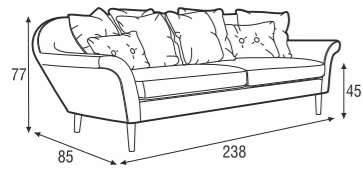

3 seater with 2 seat cushions

with 2x cushions 45x30 with buttons
+ 2x cushions 45x45 with buttons
+ 2x cushions 40x40 + 2x cushions 45x45

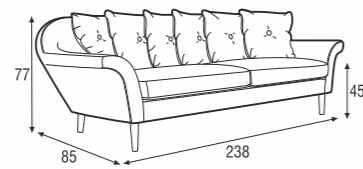

3 seater with 2 seat cushions

with 6x cushions 45x45 with button

suggested minimum number
of square cushions:

armchair - 2 pcs, 2 seater - 4 pcs, 3 seater - 5 pcs
chaiselongue - 2 pcs, set 1 - 7 pcs, set 2 - 6 pcs
set 3 - 11 pcs, set 4 - 10 pcs, set 5 - 9 pcs

TWO TYPES OF BACK CUSHIONS AVAILABLE:

lumbar cushions for:

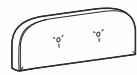

armchair



2 seater
left or right

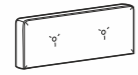

3 seater
left or right

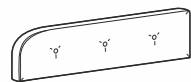

3 seater
with 2 seat cushions

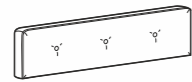

3 seater
with 3 seat cushions
left or right

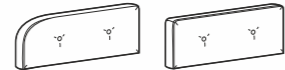

3 seater
with 3 seat cushions

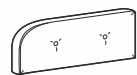

chaiselongue

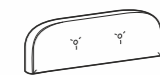

chaiselongue
freestanding

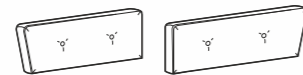

corner 90°

square cushions:

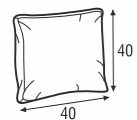

cushion
40x40

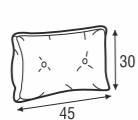

cushion 45x30
with buttons

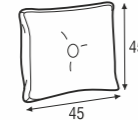

cushion 45x45
with buttons

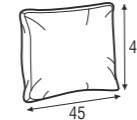

cushion
45x45

Rucola

>page 44

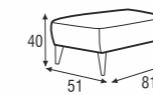

footstool

fixed cushion

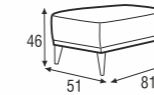

footstool

loose cushion

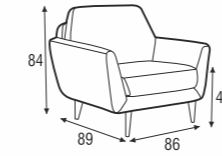

armchair

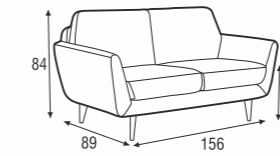

2 seater

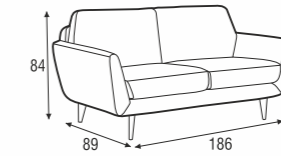

2,5 seater

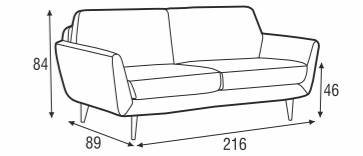

3 seater

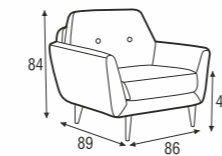

armchair

with buttons

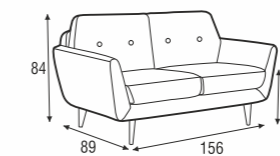

2 seater

with buttons

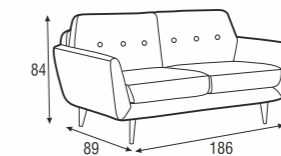

2,5 seater

with buttons

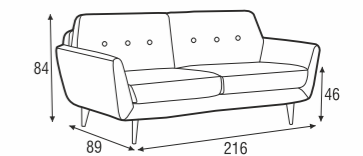

3 seater

with buttons

Shell

>page 54

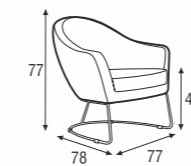

armchair

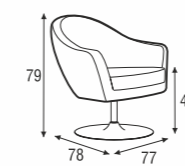

armchair swivel

Available in fabric or leather.

Stefani

>page 76

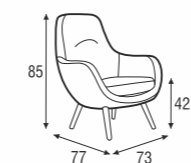

armchair

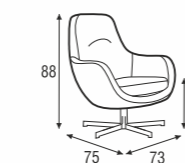

armchair with function

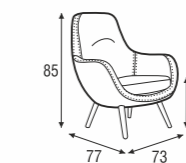

armchair

leather cover

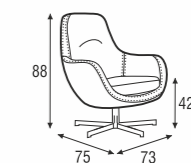

armchair with function

leather cover

Available in fabric or leather.

Tokyo

>page 36

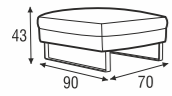

footstool 90x70

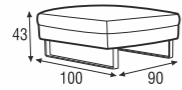

footstool 100x90

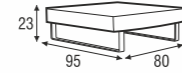

footstool frame 95x80

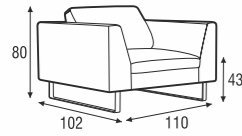

armchair

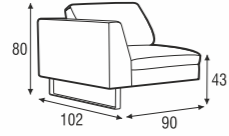

armchair left / or right

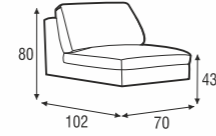

armchair without armrests

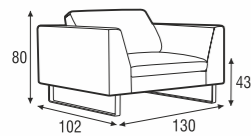

armchair wide

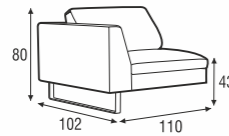

armchair wide left / or right

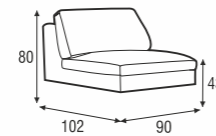

armchair without armrests

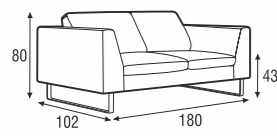

2 seater

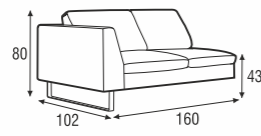

2 seater left / or right

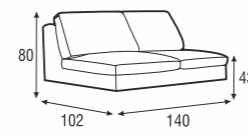

2 seater without armrests

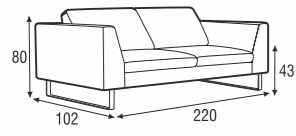

3 seater

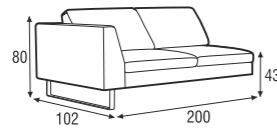

3 seater left / or right

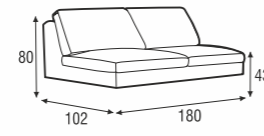

3 seater without armrests

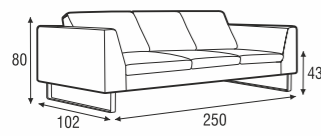

3XL seater

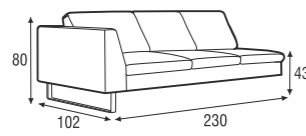

3XL seater left / or right

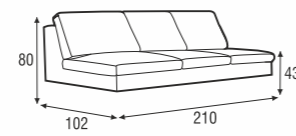

3XL seater without armrests

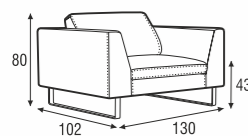

armchair wide
leather cover

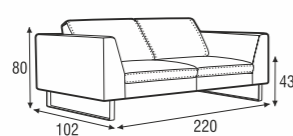

3 seater
leather cover

>>tokyo

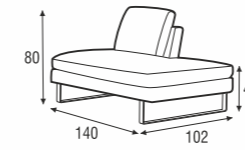

bench left / or right

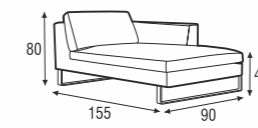

chaiselongue left / or right

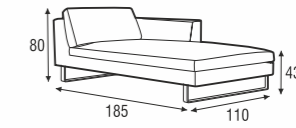

chaiselongue long left / or right

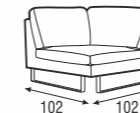

corner 90°

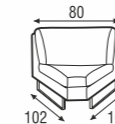

corner 30°

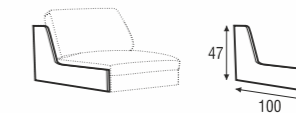

ending

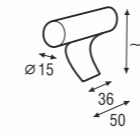

headrest with roll L-50

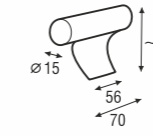

headrest with roll L-70

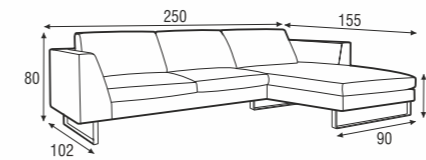

set 1 right / or left

2 seater left / or right + chaiselongue right / or left

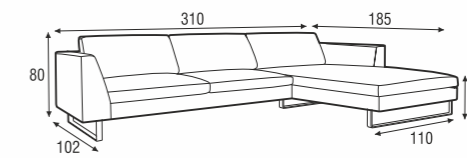

set 2 right / or left

3 seater left / or right + chaiselongue long right / or left

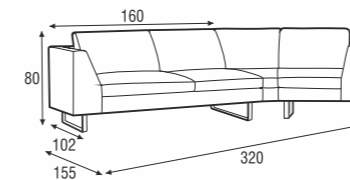

set 3 right / or left

2 seater left / or right + corner 30° + armchair right / or left

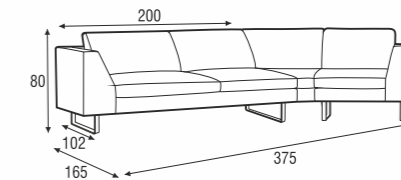

set 4 right / or left

3 seater left / or right + corner 30° + armchair wide right / or left

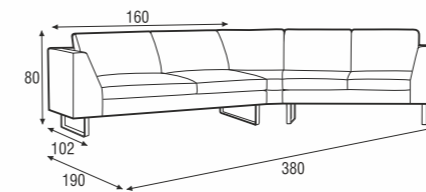

set 5

2 seater left + corner 30° + 2 seater right

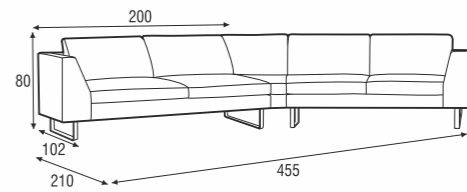

set 6

3 seater left + corner 30° + 3 seater right

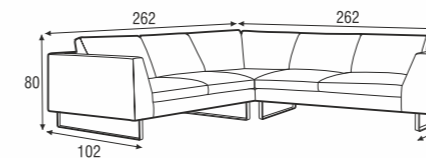

set 7

2 seater left + corner 90° + 2 seater right

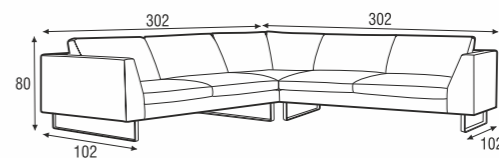

set 8

3 seater left + corner 90° + 3 seater right

>>tokyo

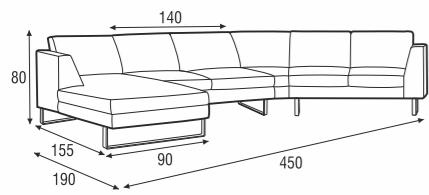

set 9 left / or right

chaiselongue left / or right + 2 seater without armrests + corner 30° + 2 seater right / or left

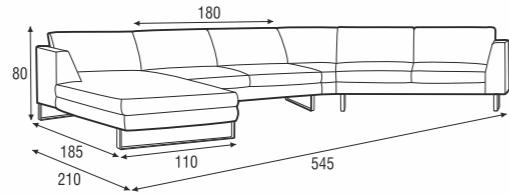

set 10 left / or right

chaiselongue long left / or right + 3 seater without armrests + corner 30° + 3 seater right / or left

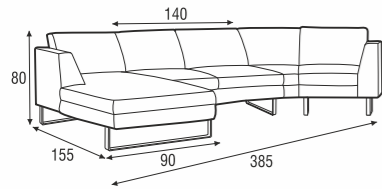

set 11 left / or right

chaiselongue left / or right + 2 seater without armrests + corner 30° + armchair right / or left

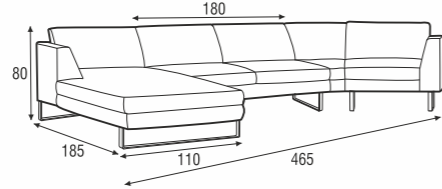

set 12 left / or right

chaiselongue long left / or right + 3 seater without armrests + corner 30° + armchair wide right / or left

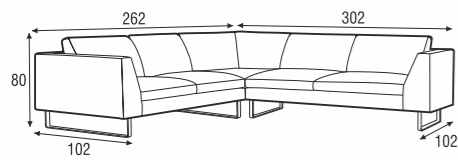

set 13 left / or right

2 seater left / or right + corner 90° + 3 seater right / or left

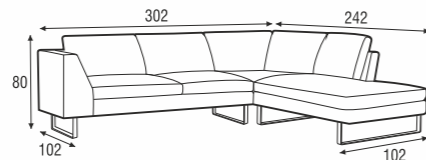

set 14 right / or left

3 seater right / or left + corner 90° + bench left / or right

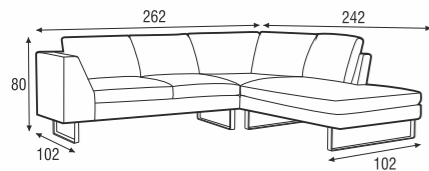

set 15 right / r left

2 seater right / or left + corner 90° + bench left / or right

Available in fabric or leather.

Ville

>page 18

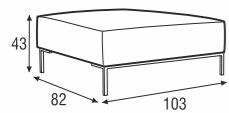

footstool 103x82

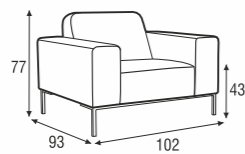

armchair

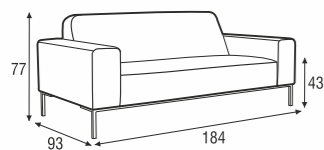

2 seater

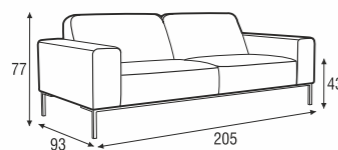

3 seater

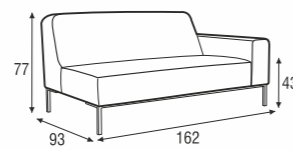

2 seater right / or left

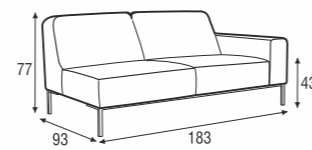

3 seater right / or left



>>ville

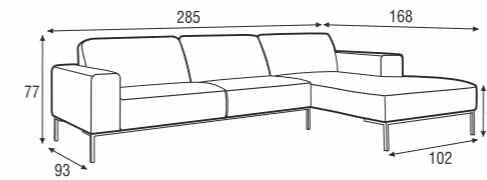

set 1 right / or left

chaiselongue right / or left + 3 seater left / or right

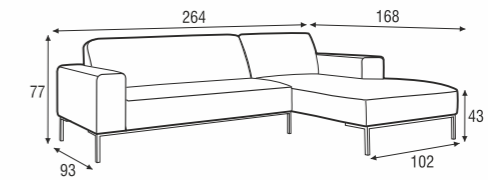

set 2 right / or left

chaiselongue right / or left + 2 seater left / or right

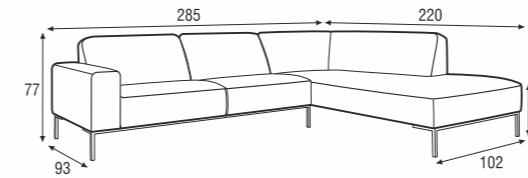

set 3 right / or left

divan right / or left + 3 seater left / or right

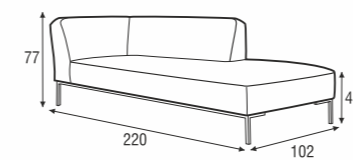

divan right / or left

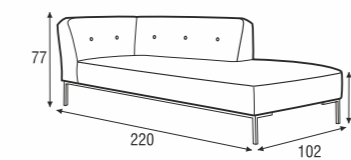

divan with buttons right / or left

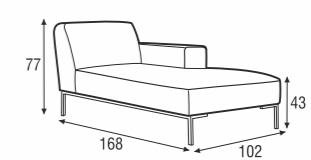

chaiselongue right / or left

plain / buttons

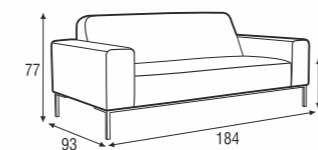

2 seater plain

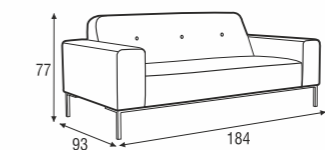

2 seater with buttons

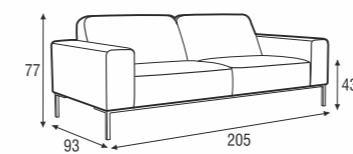

3 seater plain

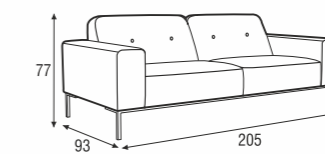

3 seater with buttons

legs

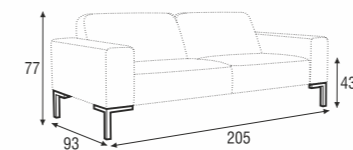

3 seater option 1
4x leg no.146



3 seater option 2
1x frame no.146a + 2x leg no.146



home & family

Antares



>page 104

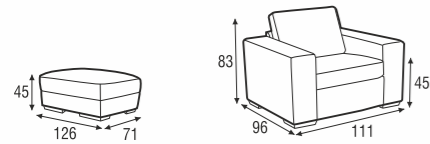

footstool armchair

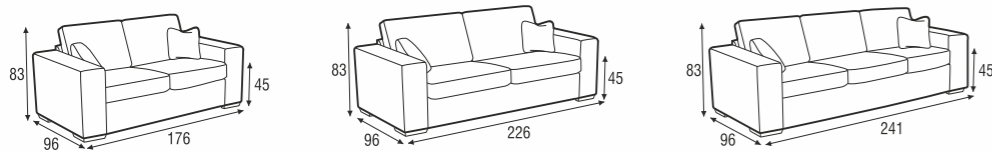

2 seater 3 seater 3,5 seater

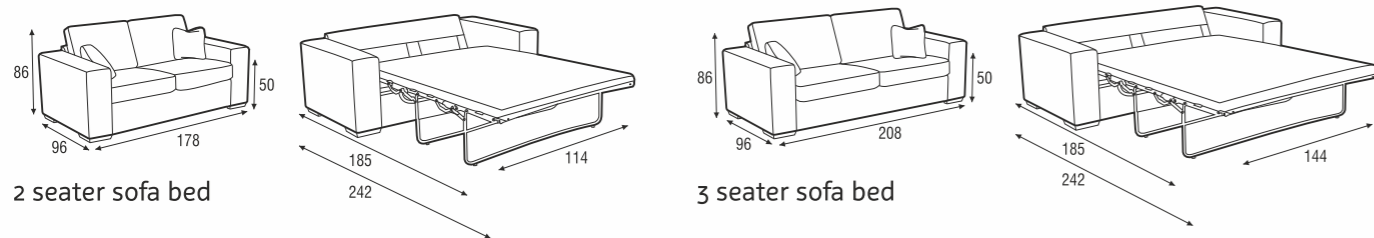

2 seater sofa bed 3 seater sofa bed

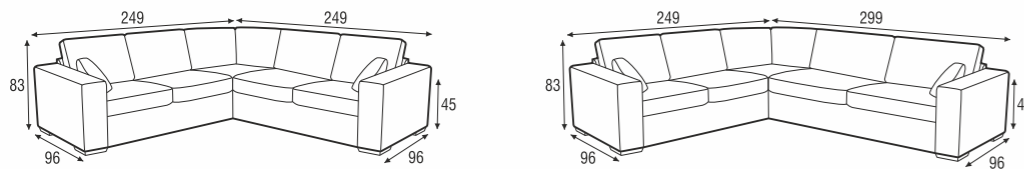

set 1 2 seater left + corner 90° + 2 seater right
set 2 left / or right 2 seater left / or right + corner 90° + 3 seater right / or left

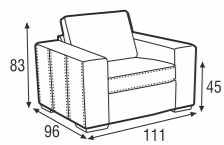

armchair
leather cover

Available in fabric or leather.

Axel



>page 82

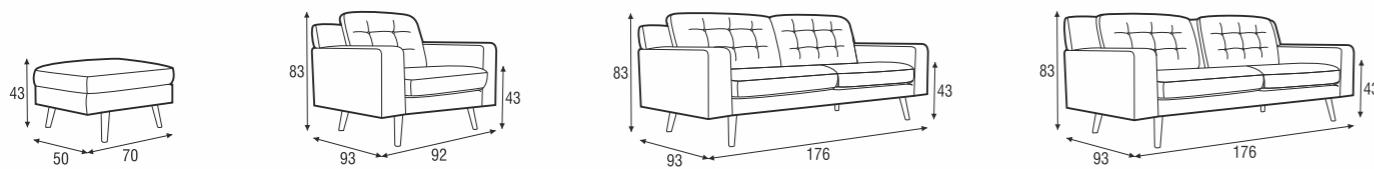

footstool armchair 2 seater 2 seater with short back cushions

>>axel

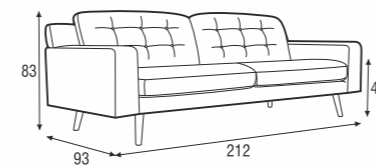

3 seater

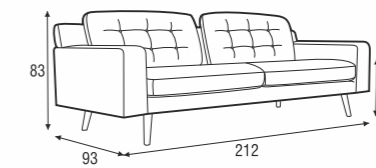

3 seater with short back cushions

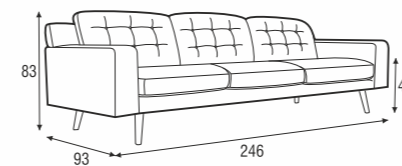

4 seater

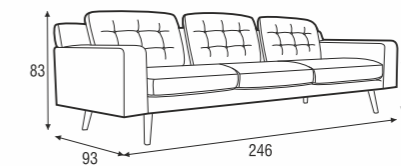

4 seater with short back cushions

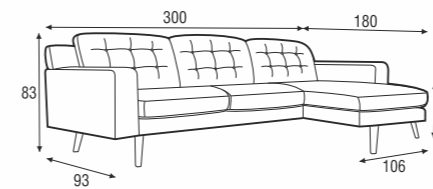

set 1 right / or left
chaiselongue right / or left + 3 seater left / or right

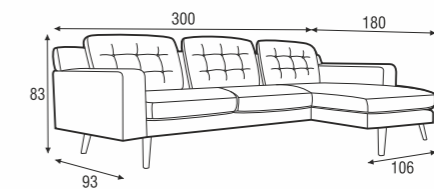

set 1 right / or left with short back cushions
chaiselongue right / or left + 3 seater left / or right

Bari



>page 122

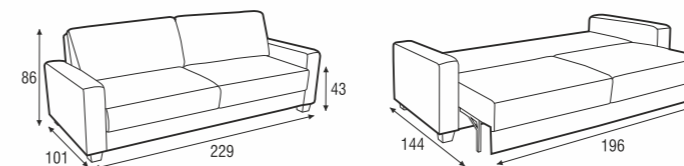

3 seater sofa bed

Circle



>page 106

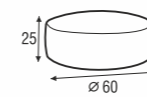

footstool

Diana bed

>page 138

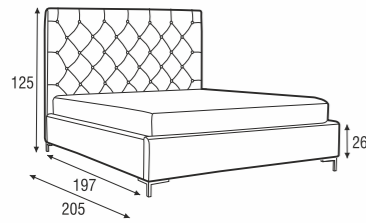

bed 149x205 / mattress 135x190

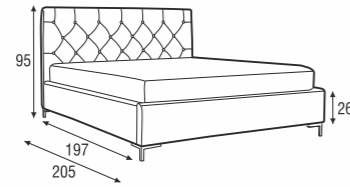

bed 149x205 / mattress 135x190

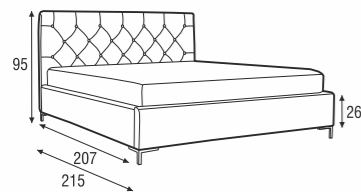

bed 154x215 / mattress 140x200
bed 164x215 / mattress 150x200
bed 174x215 / mattress 160x200
bed 194x215 / mattress 180x200
bed 214x215 / mattress 200x200

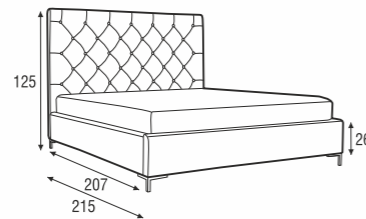

bed 154x215 / mattress 140x200
bed 164x215 / mattress 150x200
bed 174x215 / mattress 160x200
bed 194x215 / mattress 180x200
bed 214x215 / mattress 200x200

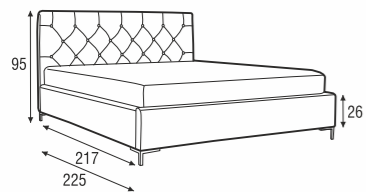

bed 154x225 / mattress 140x210
bed 174x225 / mattress 160x210
bed 194x225 / mattress 180x210
bed 214x225 / mattress 200x210

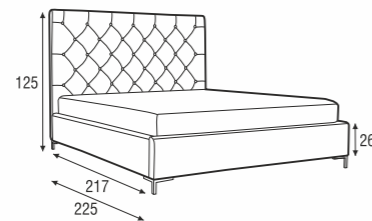

bed 154x225 / mattress 140x210
bed 174x225 / mattress 160x210
bed 194x225 / mattress 180x210
bed 214x225 / mattress 200x210

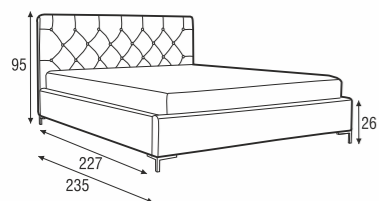

bed 194x235 / mattress 180x220
bed 214x235 / mattress 200x220

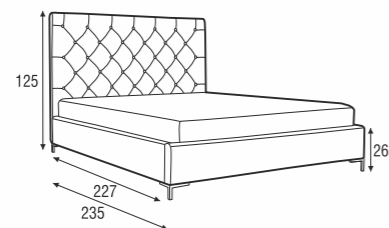

bed 194x235 / mattress 180x220
bed 214x235 / mattress 200x220

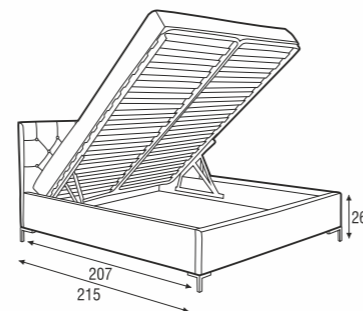

beds 154, 164, 174, 194x215
available with box (for special order)

>>diana bed

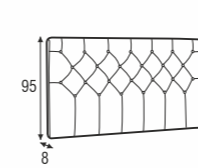

headrest 149x95x8
headrest 154x95x8
headrest 164x95x8
headrest 174x95x8
headrest 194x95x8
headrest 214x95x8

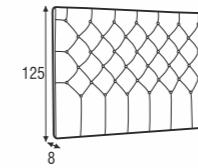

headrest 149x125x8
headrest 154x125x8
headrest 164x125x8
headrest 174x125x8
headrest 194x125x8
headrest 214x125x8

Available in fabric or leather.

Giorgio

>page 96

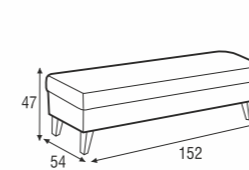

footstool

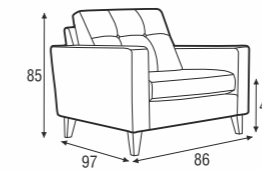

armchair

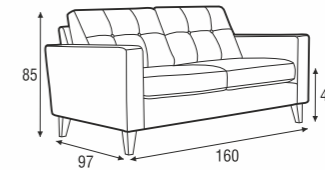

2 seater

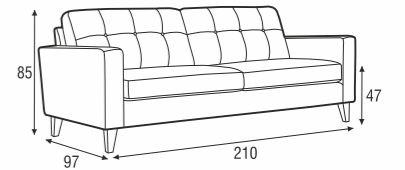

3 seater

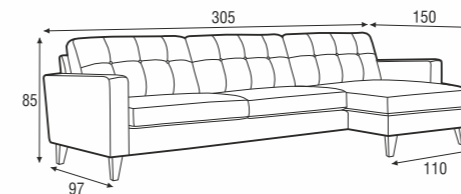

set 1 left / or right

3 seater left / or right + chaiselongue wide right / or left

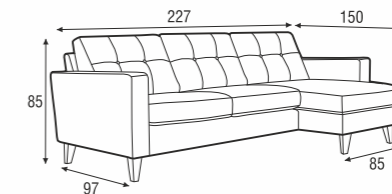

set 2 left / or right

2 seater left / or right + chaiselongue right / or left

Available in fabric (standard or lux comfort) or leather (only standard comfort).

Greta

>page 124

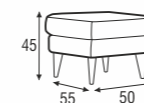

footstool

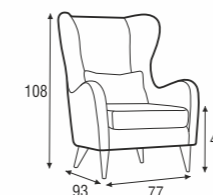

armchair

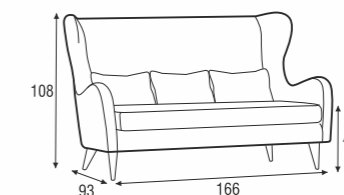

2,5 seater

>>greta

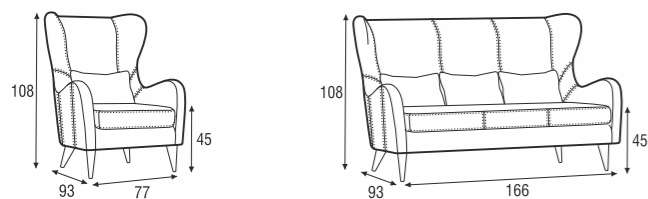

armchair
leather cover

2,5 seater
leather cover

Available in fabric or leather.

Hebe bed

>page 136

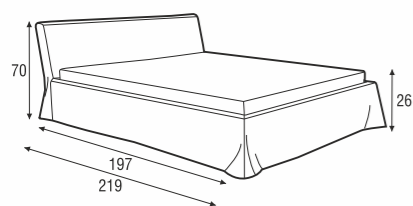

bed 149x219 / mattress 135x190

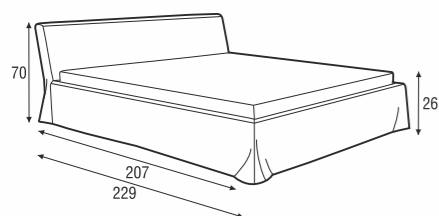

bed 154x229 / mattress 140x200
bed 164x229 / mattress 150x200
bed 174x229 / mattress 160x200
bed 194x229 / mattress 180x200
bed 214x229 / mattress 200x200

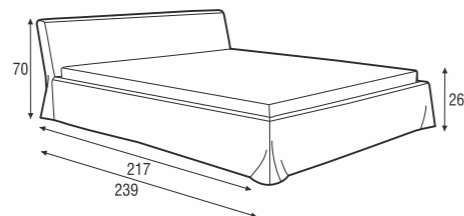

bed 154x239 / mattress 140x210
bed 174x239 / mattress 160x210
bed 194x239 / mattress 180x210
bed 214x239 / mattress 200x210

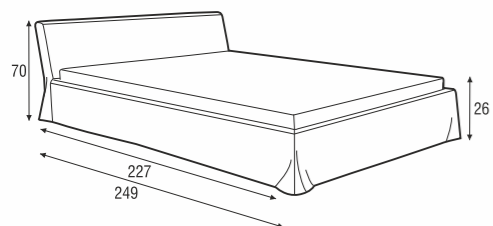

bed 194x249 / mattress 180x220
bed 214x249 / mattress 200x220

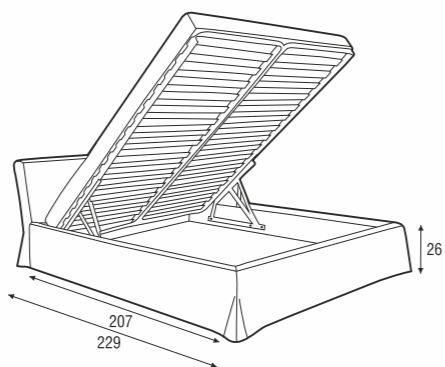

Beds 154, 164, 174, 194x229
available with box (for special order)

Available in fabric or leather.

Humphrey

>page 126

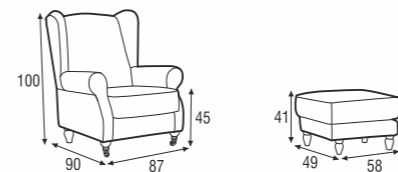

armchair high

footstool 58x49



Jenny

>page 80

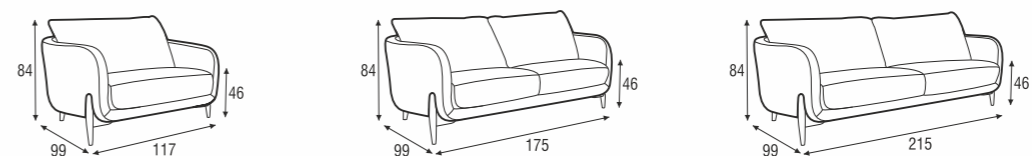

armchair wide ver.A

2 seater ver.A

3 seater ver.A



corner 90° ver.A

chaiselongue ver.A

chaiselongue wide ver.A

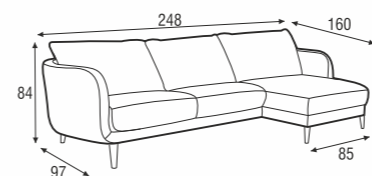

set 1 right / or left

2 seater left / or right + chaiselongue right / or left

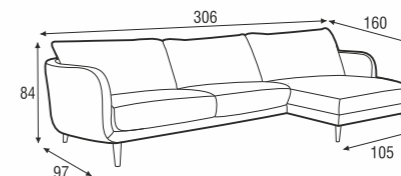

set 2 right / or left

3 seater left / or right + chaiselongue wide right / or left

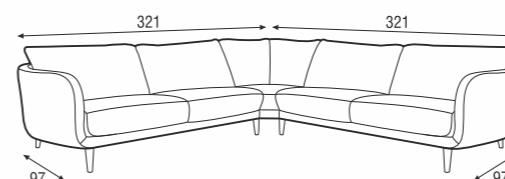

set 3

3 seater left + corner 90° + 3 seater right

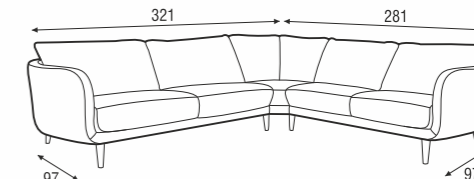

set 4 right / or left

3 seater left / or right + corner 90° + 2 seater right / or left



>>jenny

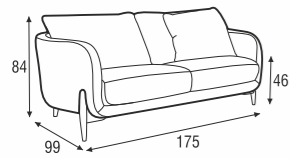

2 seater ver.B

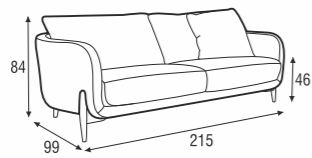

3 seater ver.B

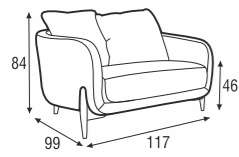

armchair wide ver.C

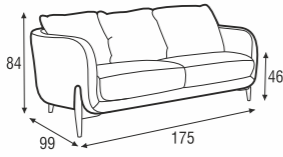

2 seater ver.C

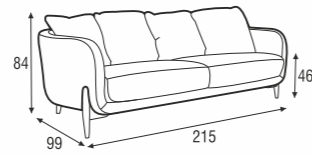

3 seater ver.C

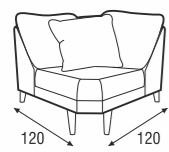

corner 90° ver.C

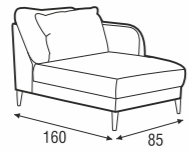

chaiselongue ver.C

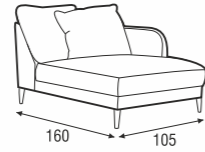

chaiselongue wide ver.C

EXAMPLES

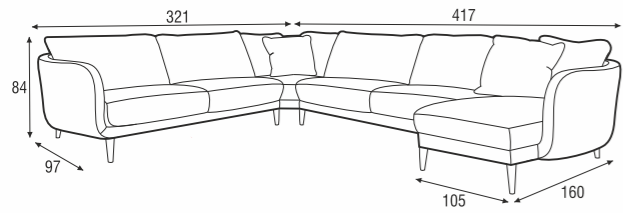

set 1 with back cushions

3 seater ver.A left / or right + corner 90° ver.C + 3 seater without armrests ver.A + chaiselongue wide ver.C right / or left ver.C

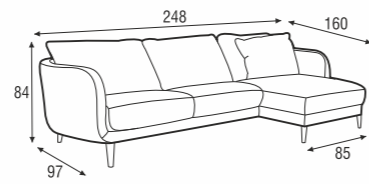

set 2 with back cushions

2 seater ver.A left / or right + chaiselongue ver.C right / or left

Kalle

>page 114

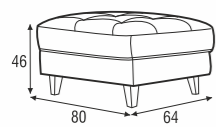

footstool

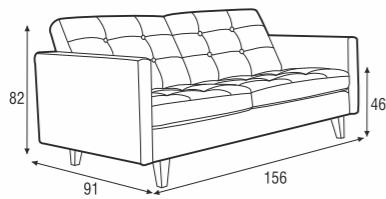

2 seater

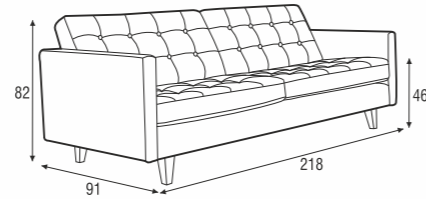

3 seater

Klara

>page 88

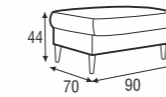

footstool

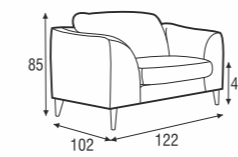

armchair

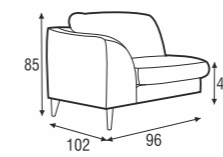

armchair left / or right

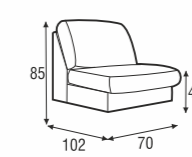

armchair without armrests

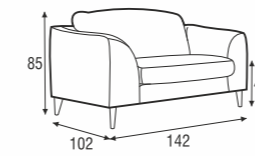

armchair wide

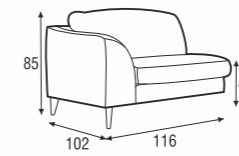

armchair wide left / or right

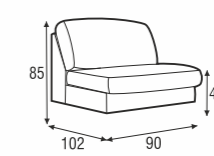

armchair wide without armrests

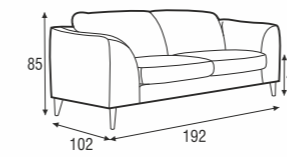

2 seater

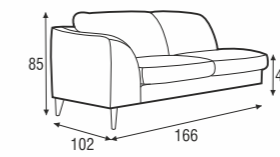

2 seater left / or right

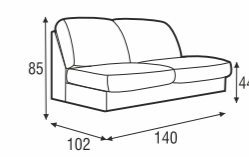

2 seater without armrests

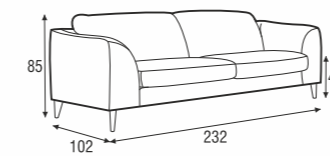

3 seater

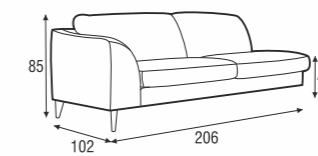

3 seater left / or right

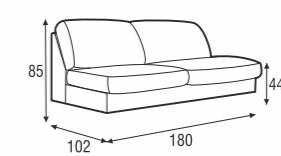

3 seater without armrests

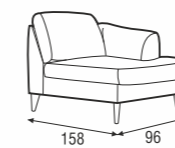

chaiselongue right / or left

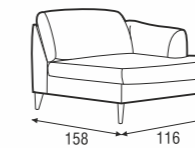

chaiselongue wide right / or left

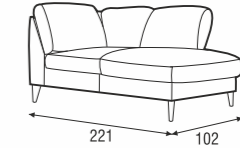

divan right / or left

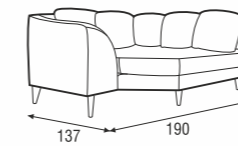

cozy corner left / or right

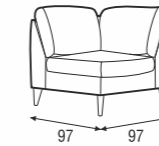

corner 90° no.1

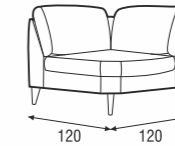

corner 90° no.2

>>klara

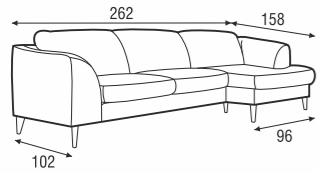

set 1 right / or left

chaiselongue right / or left + 2 seater left / or right

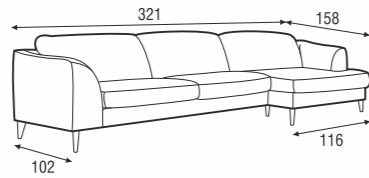

set 2 right / or left

chaiselongue wide right / or left + 3 seater left / or right

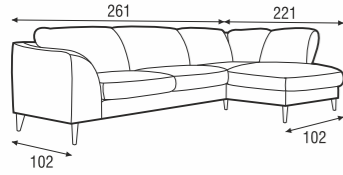

set 3 right / or left

divan right / or left + 2 seater left / or right

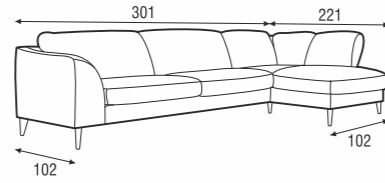

set 4 right / or left

divan right / or left + 3 seater left / or right

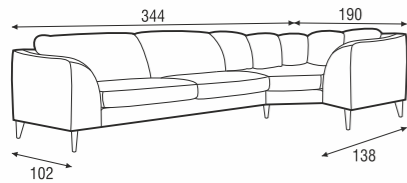

set 5 right / or left

cozy corner right / or left + 3 seater left / or right

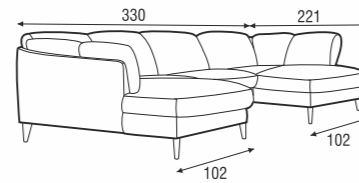

set 6

divan right + 2 seater without armrests + divan left

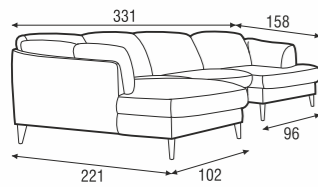

set 7 right / or left

chaiselongue right / or left + 2 seater without armrests + divan left / or right

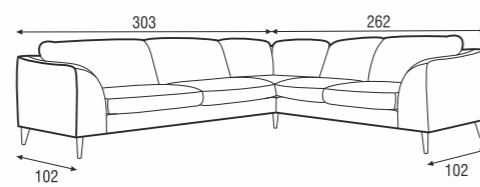

set 8 right / or left

2 seater right / or left + corner 90° no.1 + 3 seater left / or right

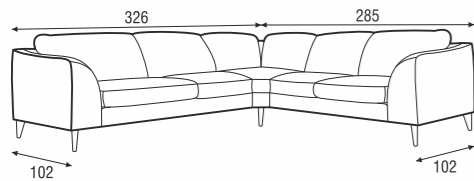

set 9 right / or left

2 seater right / or left + corner 90° no.2 + 3 seater left / or right

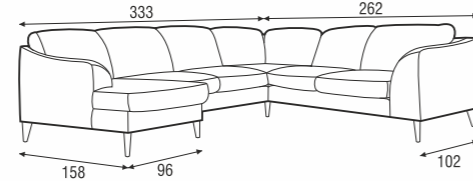

set 10 right / or left

chaiselongue right / or left + 2 seater without armrests + corner 90° no.1 + 2 seater left / or right

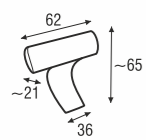

headrest L-62

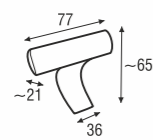

headrest L-77

Koriander

>page 112

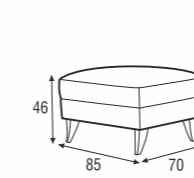

footstool 85x70

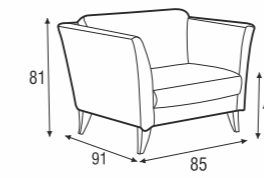

armchair

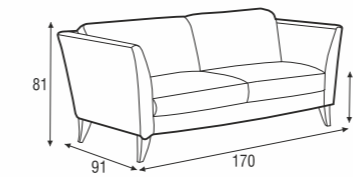

2 seater

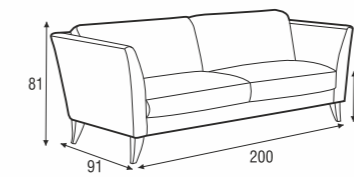

3 seater

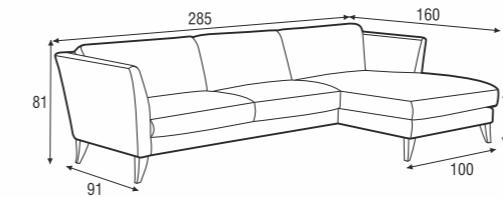

set 1 right / or left

3 seater left / or right + chaiselongue right / or left

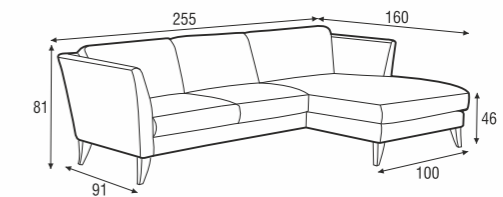

set 2 right / or left

2 seater left / or right + chaiselongue right / or left

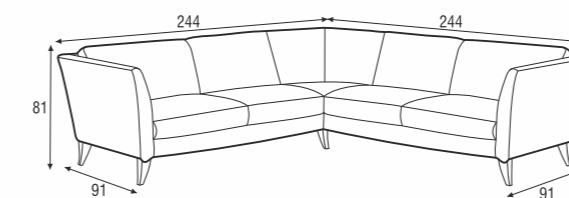

set 3

2 seater left + corner 90° + 2 seater right

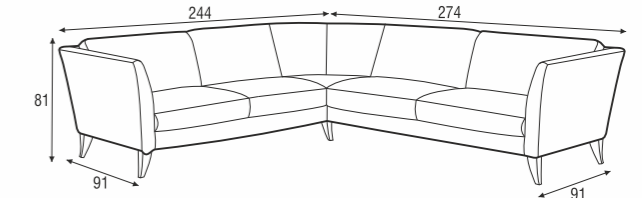

set 4 right / or left

2 seater left / or right + corner 90° + 3 seater right / or left

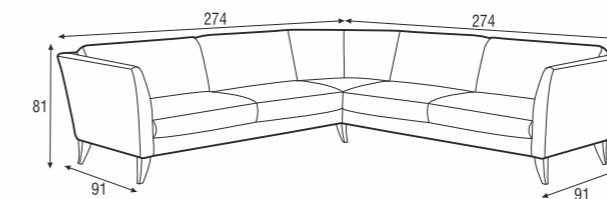

set 5

3 seater left + corner 90° + 3 seater right

Leon bed

>page 140

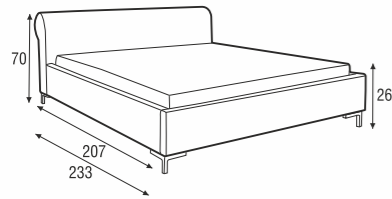

bed 154x233 / mattress 140x200
 bed 164x233 / mattress 150x200
 bed 174x233 / mattress 160x200
 bed 194x233 / mattress 180x200
 bed 214x233 / mattress 200x200

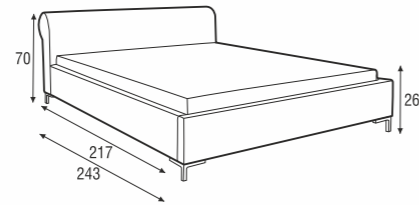

bed 154x243 / mattress 140x210
 bed 174x243 / mattress 160x210
 bed 194x243 / mattress 180x210
 bed 214x243 / mattress 200x210

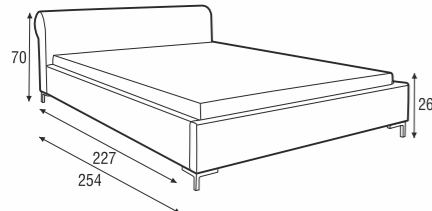

bed 194x254 / mattress 180x220
 bed 214x254 / mattress 200x220

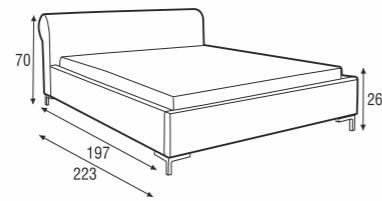

bed 149x223 / mattress 135x190

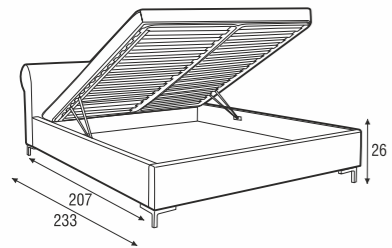

Beds 154, 164, 174, 194x233
 available with box (for special order)

Available in fabric or leather.

Linn

>page 132

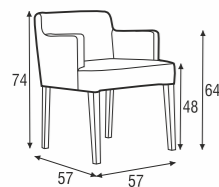

chair

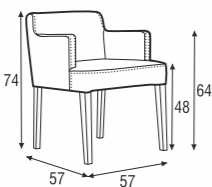

leather chair

Available in fabric or leather.



Lotta

>page 116

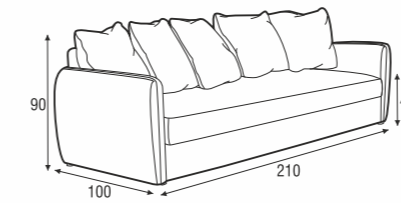

3 seater sofa bed



PAD

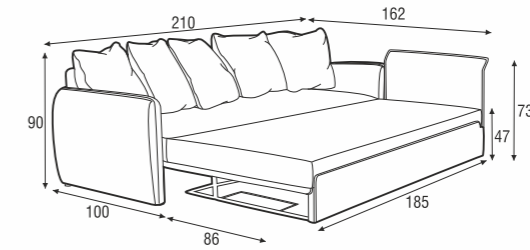

3 seater sofa bed

Lukas

>page 120

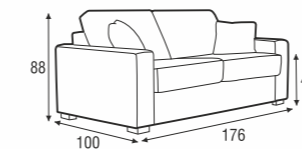

2 seater sofa bed

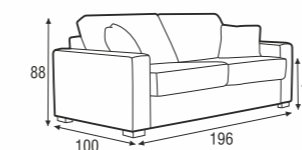
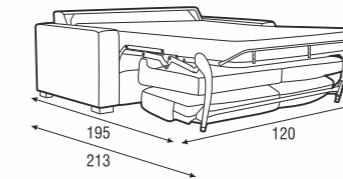

3 seater sofa bed

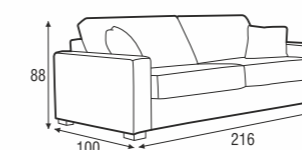
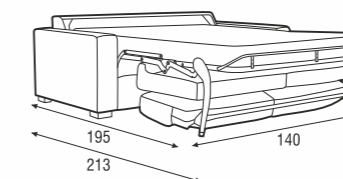

4 seater sofa bed

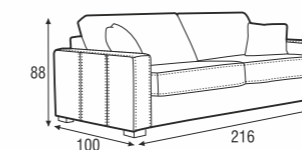
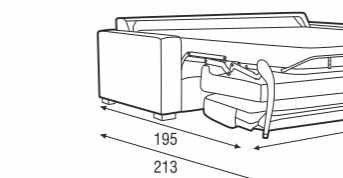

4 seater sofa bed

leather cover



>>lukas

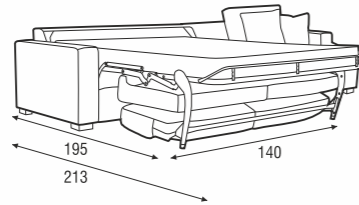
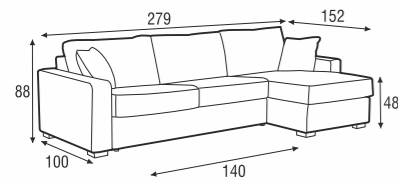

set 1 right / or left

3 seater sofa bed left / or right + chaiselongue right / or left

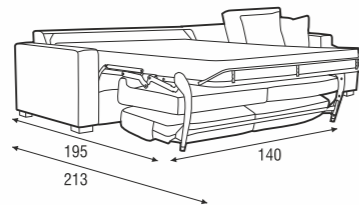
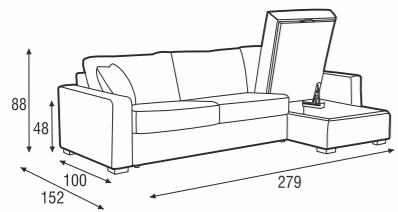

set 2 right / or left

3 seater sofa bed left / or right + chaiselongue with box right / or left

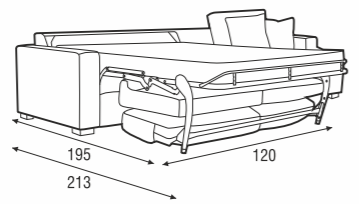
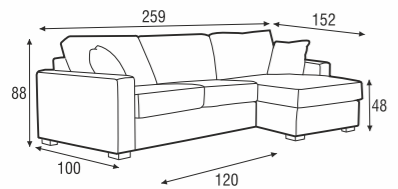

set 3 right / or left

2 seater sofa bed left / or right + chaiselongue right / or left

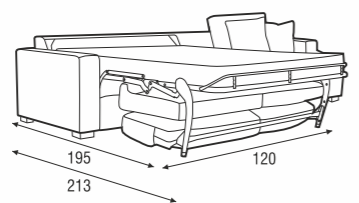
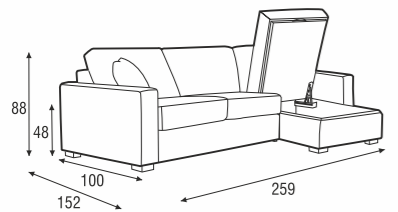

set 4 right / or left

2 seater sofa bed left / or right + chaiselongue with box right / or left

armrests

Drawings show combinations with armrest II. Combinations with armrest I and III are properly longer or shorter in width.

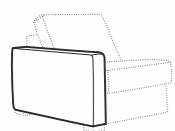

armrest I

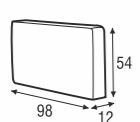

armrest II

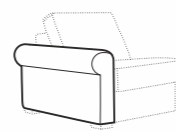
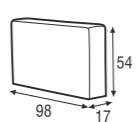
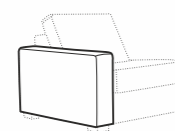

armrest III

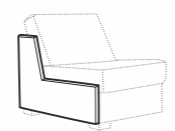
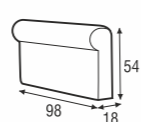

endpart left / or right

2 different mattress: foam or bonell available. Available in fabric or leather.

Luna bed

>page 134

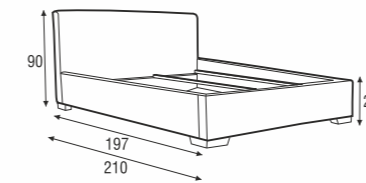

bed 149x210 / mattress 135x190

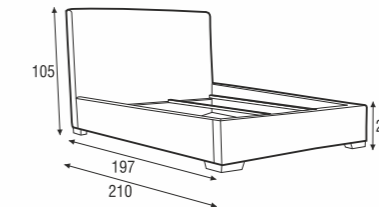

bed 149x210 / mattress 135x190

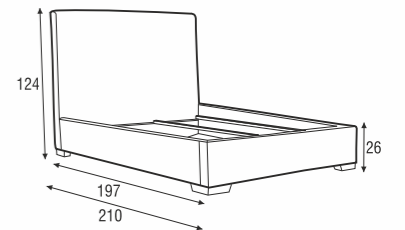

bed 149x210 / mattress 135x190

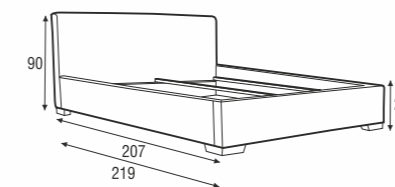

bed 154x219 / mattress 140x200
bed 164x219 / mattress 150x200
bed 174x219 / mattress 160x200
bed 194x219 / mattress 180x200
bed 214x219 / mattress 200x200

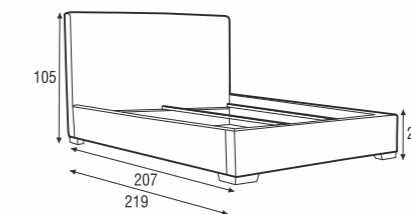

bed 154x219 / mattress 140x200
bed 164x219 / mattress 150x200
bed 174x219 / mattress 160x200
bed 194x219 / mattress 180x200
bed 214x219 / mattress 200x200

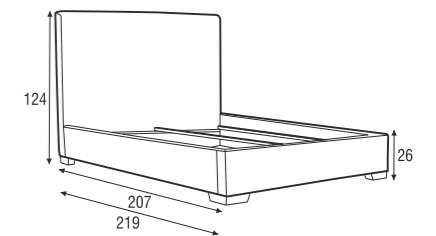

bed 154x219 / mattress 140x200
bed 164x219 / mattress 150x200
bed 174x219 / mattress 160x200
bed 194x219 / mattress 180x200
bed 214x219 / mattress 200x200

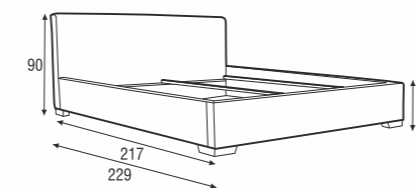

bed 154x229 / mattress 140x210
bed 174x229 / mattress 160x210
bed 194x229 / mattress 180x210
bed 214x229 / mattress 200x210

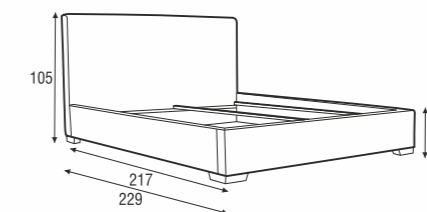

bed 154x229 / mattress 140x210
bed 174x229 / mattress 160x210
bed 194x229 / mattress 180x210
bed 214x229 / mattress 200x210

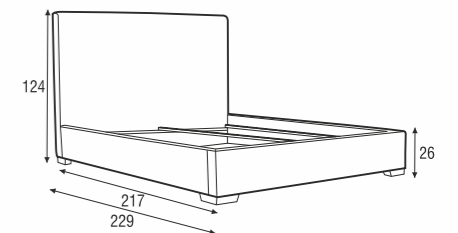

bed 154x229 / mattress 140x210
bed 174x229 / mattress 160x210
bed 194x229 / mattress 180x210
bed 214x229 / mattress 200x210

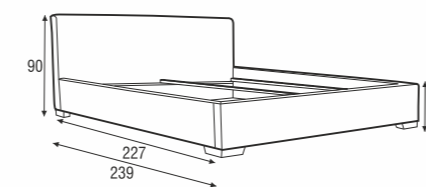

bed 194x239 / mattress 180x220
bed 214x239 / mattress 200x220

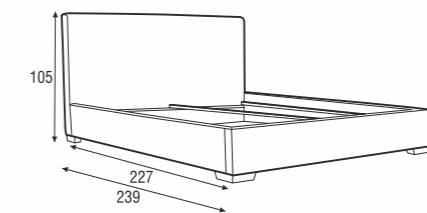

bed 194x239 / mattress 180x220
bed 214x239 / mattress 200x220

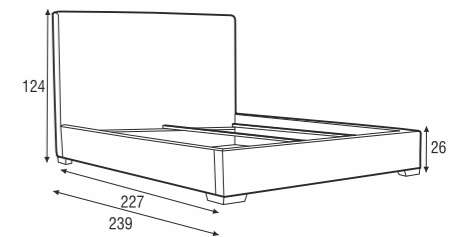

bed 194x239 / mattress 180x220
bed 214x239 / mattress 200x220

>>luna bed

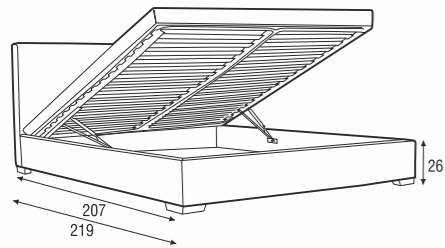

Beds 154, 164, 174, 194x219
available with box (for special order)

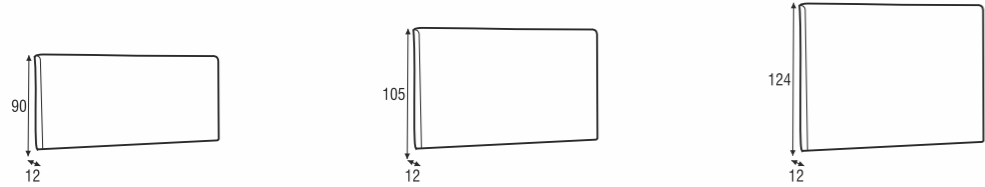

headrest 154x90x12	headrest 154x105x12	headrest 154x124x12
headrest 164x90x12	headrest 164x105x12	headrest 164x124x12
headrest 174x90x12	headrest 174x105x12	headrest 174x124x12
headrest 194x90x12	headrest 194x105x12	headrest 194x124x12
headrest 214x90x12	headrest 214x105x12	headrest 214x124x12

Available in fabric or leather.

Malin

>page 90

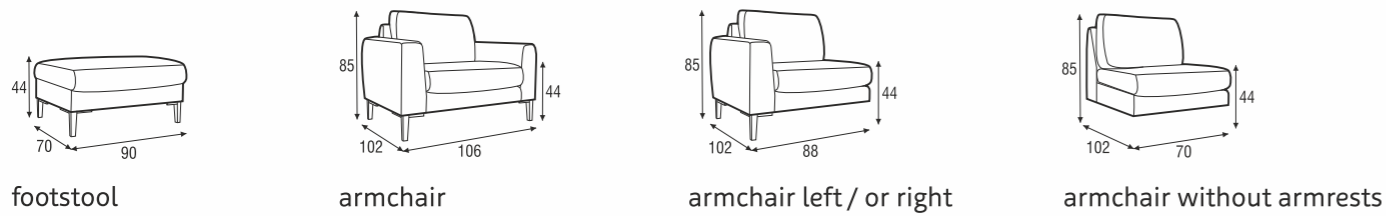

footstool armchair armchair left / or right armchair without armrests

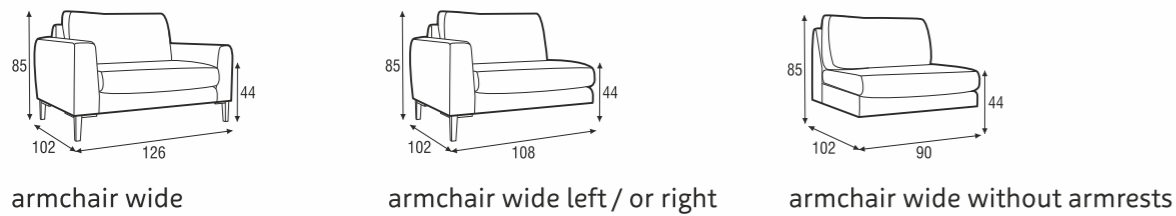

armchair wide armchair wide left / or right armchair wide without armrests

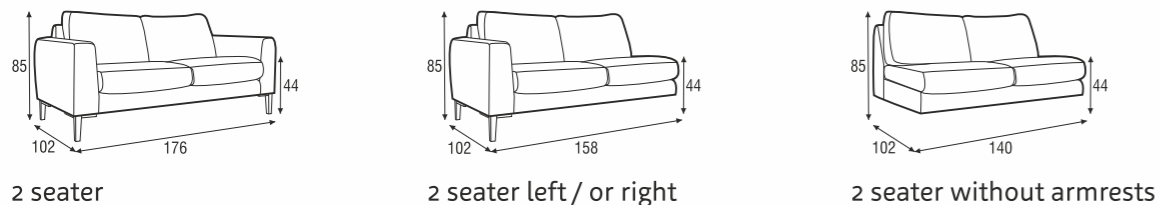

2 seater 2 seater left / or right 2 seater without armrests

>>malin

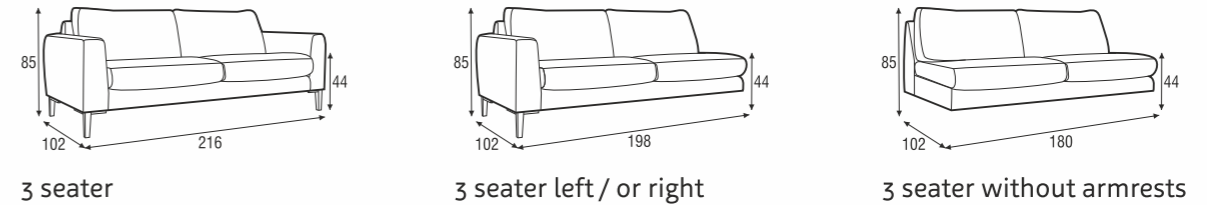

3 seater 3 seater left / or right 3 seater without armrests



chaiselongue right / or left chaiselongue wide right / or left divan right / or left

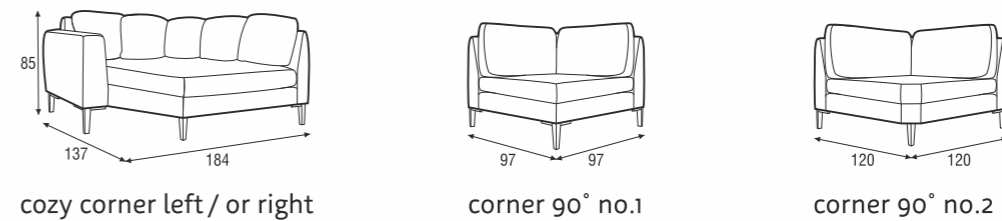

cozy corner left / or right corner 90° no.1 corner 90° no.2



set 1 right / or left
2 seater left / or right + chaiselongue right / or left

set 2 right / or left
3 seater left / or right + chaiselongue wide right / or left



set 3 right / or left
2 seater left / or right + divan right / or left

set 4 right / or left
3 seater left / or right + divan right / or left

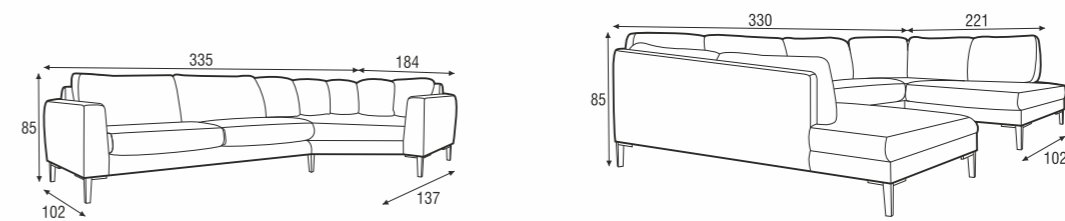

set 5 right / or left
3 seater left / or right + cozy corner right / or left

set 6
divan left + 2 seater without armrests + divan right

>> malin

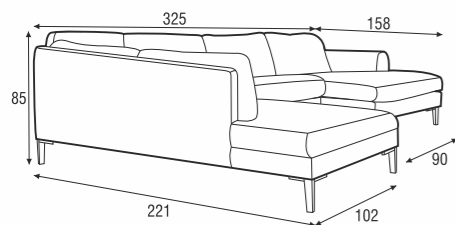

set 7 right / or left

divan left / or right + 2 seater without armrests + chaiselongue right / or left

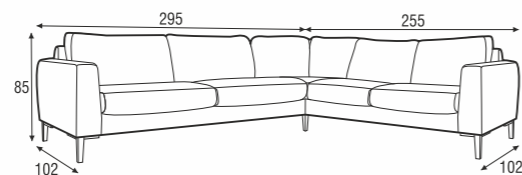

set 8 right / or left

3 seater left / or right + corner 90° no.1 + 2 seater right / or left

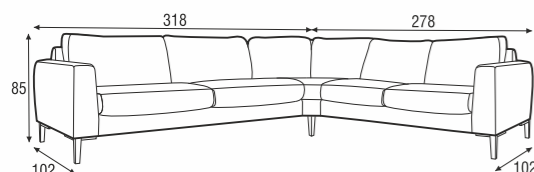

set 9 right / or left

3 seater left / or right + corner 90° no.2 + 2 seater right / or left

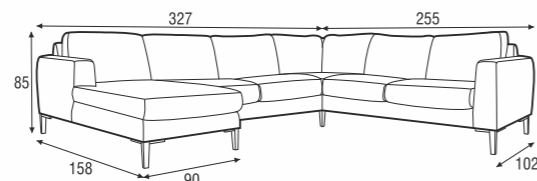

set 10 right / or left

chaiselongue left / or right + 2 seater without armrests + corner 90° no.1 + 2 seater right / or left

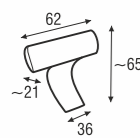

headrest L-62

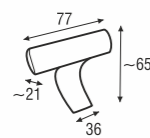

headrest L-77

>> milano

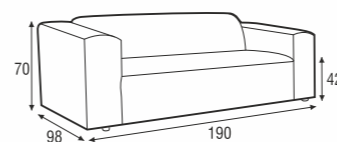

2 seater

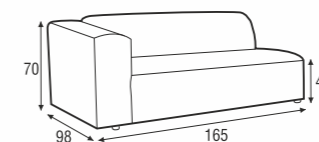

2 seater left / or right

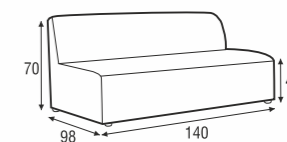

2 seater without armrest

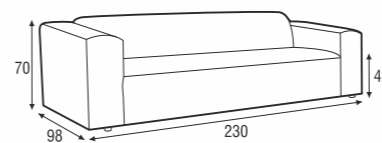

3 seater

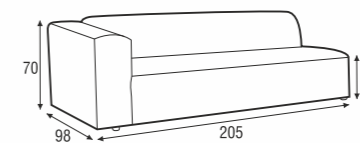

3 seater left / or right

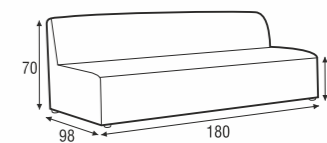

3 seater without armrest

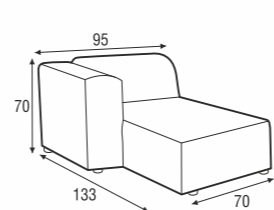

chaiselongue 70 left / or right

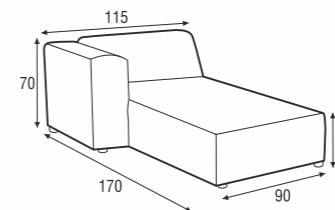

chaiselongue 90 left / or right

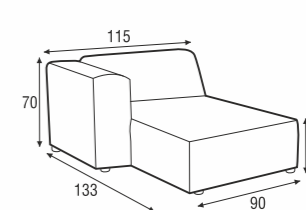

chaiselongue 90 short left / or right

Milano



>page 110

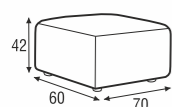

footstool 70x60

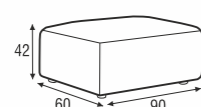

footstool 90x60

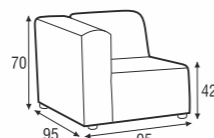

corner 90°

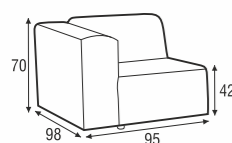

element 70 left / or right

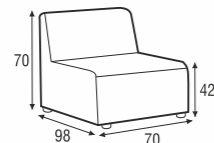

element 70 without armrests

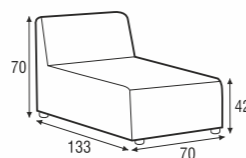

element 70x133 without armrest

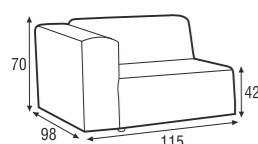

element 90 left / or right

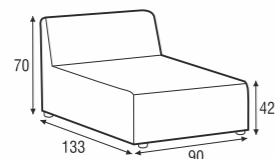

element 90x133 without armrests

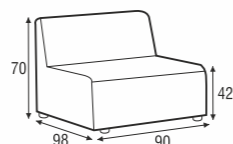

element 90x98 without armrests

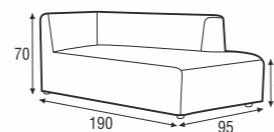

divan left / or right

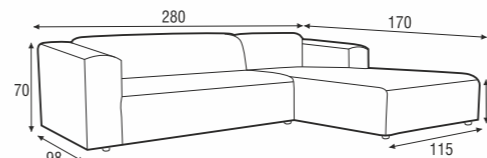

set 1 right / or left

2 seater left / or right + chaiselongue right / or left

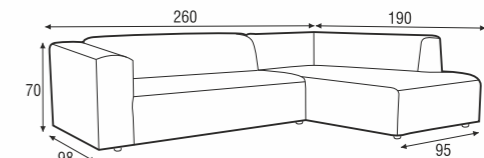

set 2 right / or left

2 seater left / or right + divan right / or left

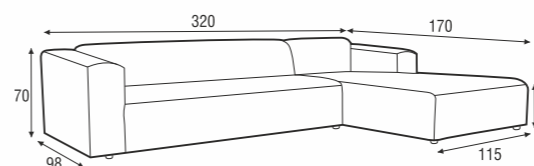

set 3 right / or left

3 seater left / or right + chaiselongue right / or left

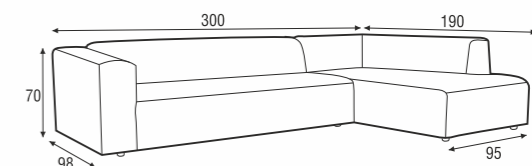

set 4 right / or left

3 seater left / or right + divan right / or left

Mynta

>page 109

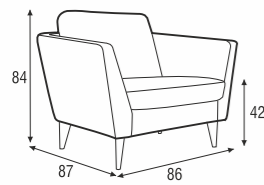

armchair

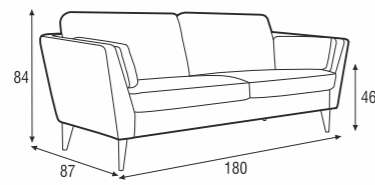

2 seater

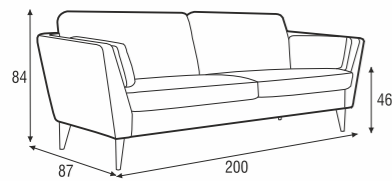

2,5 seater

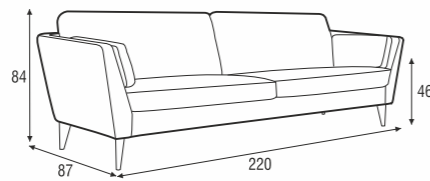

3 seater

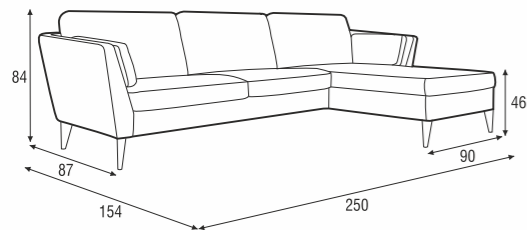

set 1 right / or left

2 seater left / or right + chaiselongue right / or left

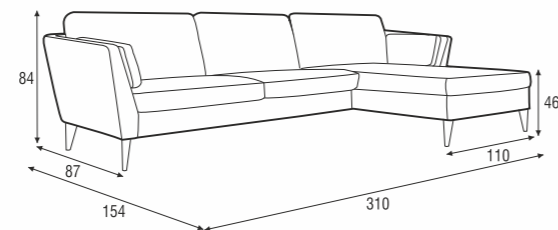

set 2 right / or left

3 seater left / or right + chaiselongue right / or left

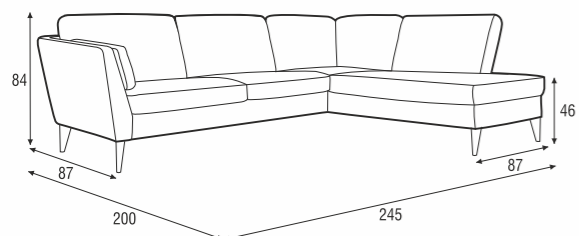

set 3 right / or left

2 seater left / or right + divan right / or left

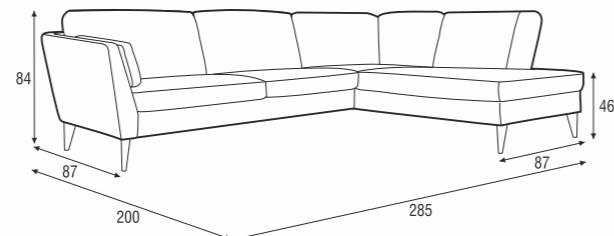

set 4 right / or left

3 seater left / or right + divan right / or left

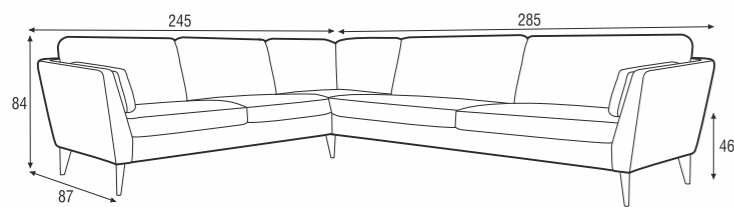

set 5 right / or left

3 seater left / or right + corner 90° + 2 seater right / or left

>>mynta

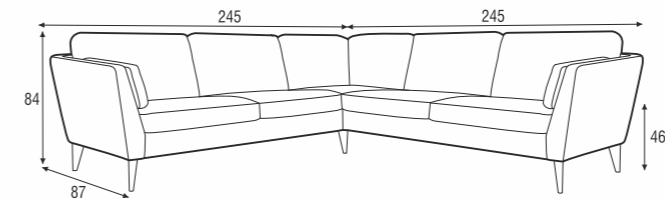

set 6

2 seater left + corner 90° + 2 seater right

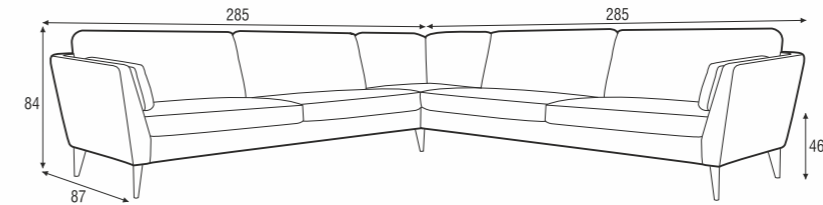

set 7

3 seater left + corner 90° + 3 seater right

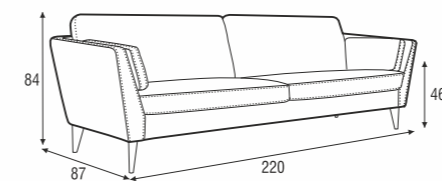

3 seater

leather cover

backrest with cushion

movable backrest at any time

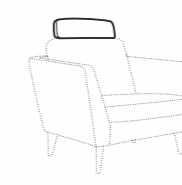
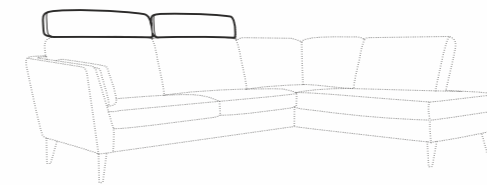

143x24x15 cm for 2 seater
163x24x15 cm for 2,5 seater
183x24x15 cm for 3 seater

48x24x15 cm for armchair

Available in fabric or leather.

Neppi

>page 108

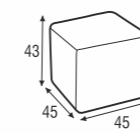

footstool

Available in fabric or leather.



Olle

>page 84

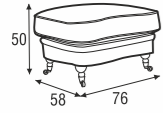

footstool

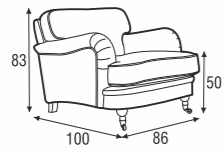

armchair

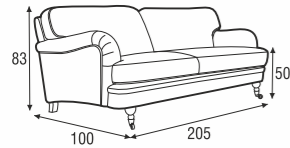

3 seater

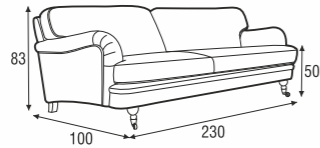

3,5 seater (2 cushions)

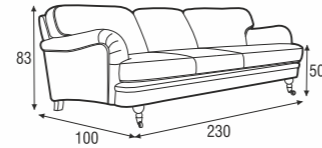

3,5 seater (3 cushions)

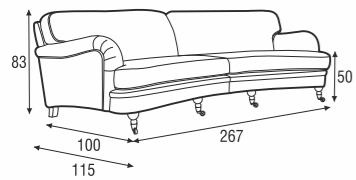

3,5 seater round (2 cushions)

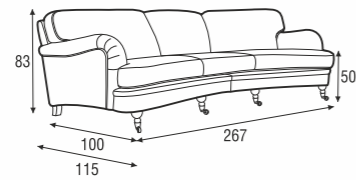

3,5 seater round (3 cushions)

Passion

>page 100

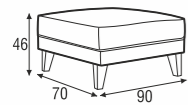

footstool 90x70

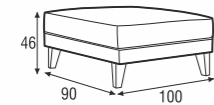

footstool 100x90

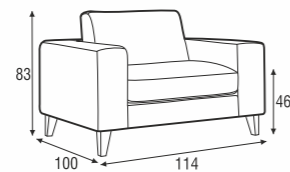

armchair

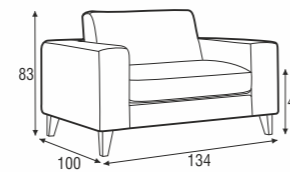

armchair wide

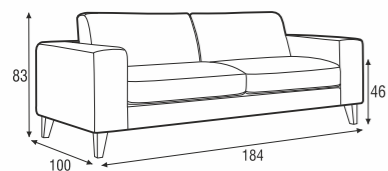

2 seater

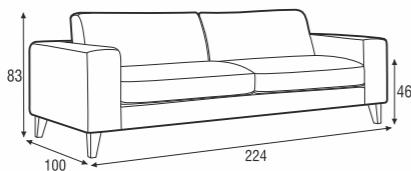

3 seater

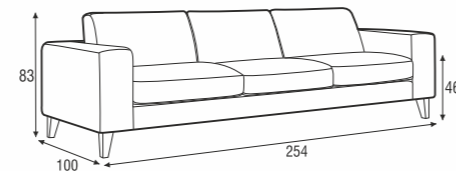

3XL seater

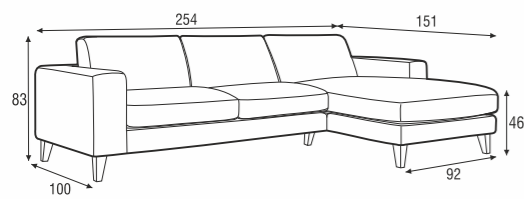

set 1 right / or left

2 seater left / or right + chaiselongue right / or left

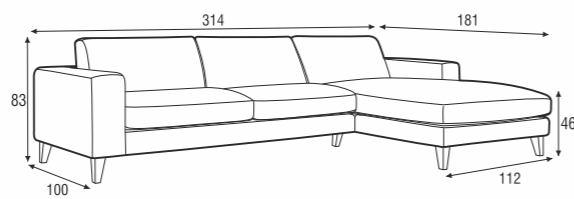

set 2 right / or left

3 seater left / or right + chaiselongue long right / or left

>>passion

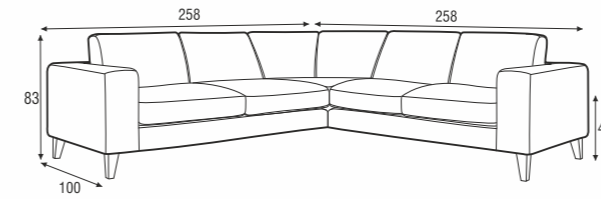

set 3

2 seater right + corner 90° + 2 seater left

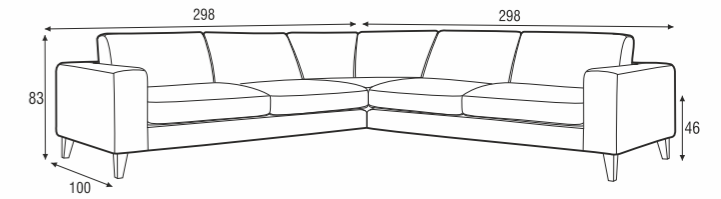

set 4

3 seater right + corner 90° + 3 seater left

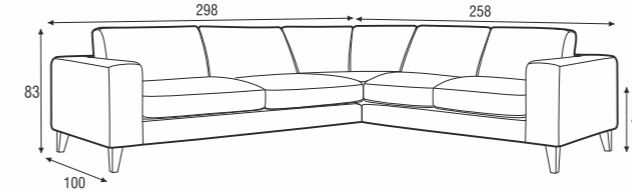

set 5 left / or right

3 seater right / or left + corner 90° + 2 seater left / or right

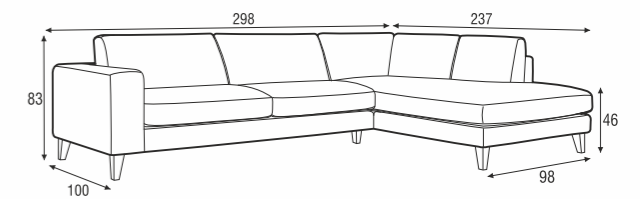

set 6 right / or left

3 seater left / or right + corner 90° + bench right / or left

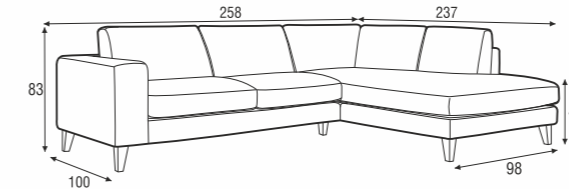

set 7 right / or left

2 seater left / or right + corner 90° + bench right / or left

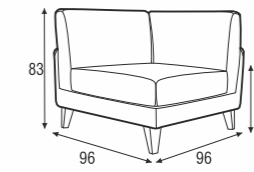

corner 90°

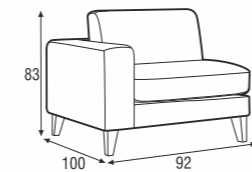

armchair

left / or right

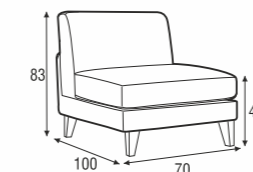

armchair

without armrest

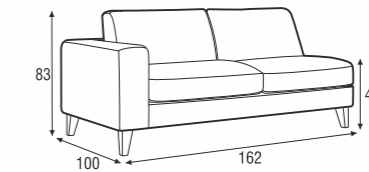

2 seater

left / or right

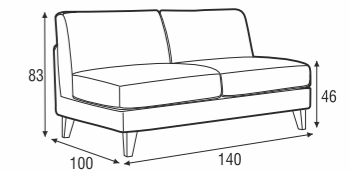

2 seater

without armrest

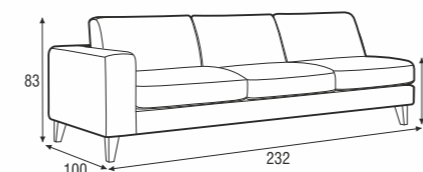

3XL seater

left / or right

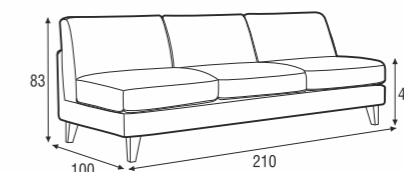

3XL seater

without armrest

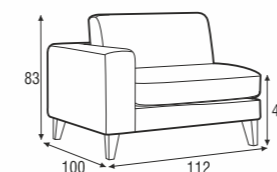

armchair wide

left / or right

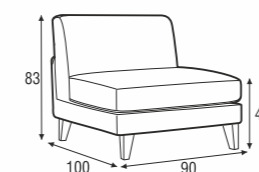

armchair wide

without armrest

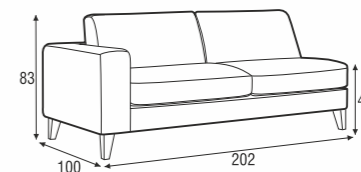

3 seater

left / or right

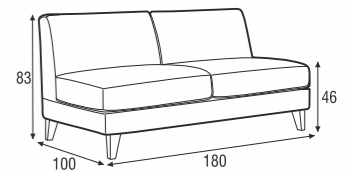

3 seater

without armrest

>>passion

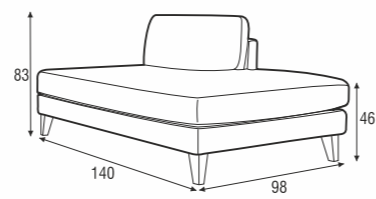
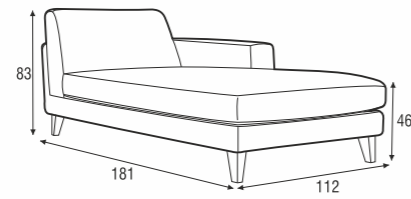
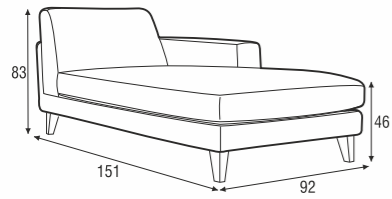

chaiselongue
left / or right

chaiselongue long
left / or right

bench
left / or right

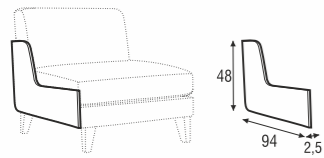

endpart left / or right

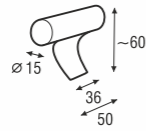

headrest with roll L-50

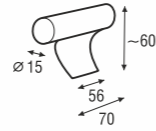

headrest with roll L - 70

Puk

>page 118

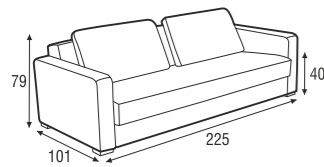

3 seater sofa bed

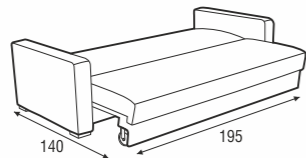

Quattro

>page 98

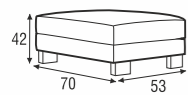

footstool 70x53

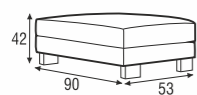

footstool 90x53

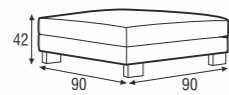

footstool 90x90

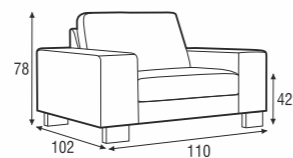

armchair 70

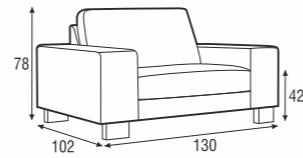

armchair 90

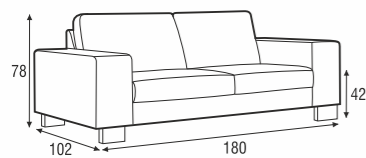

2 seater 70

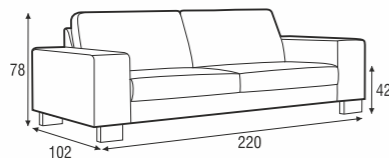

3 seater 90

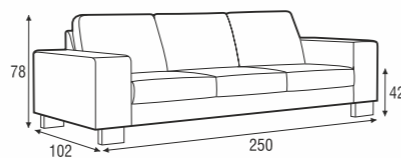

3 seater XL 70



>>quattro

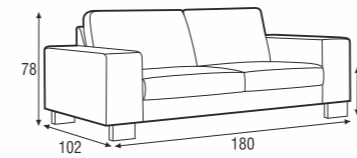

sofa bed

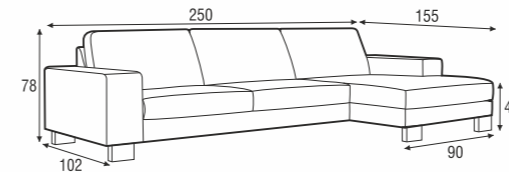
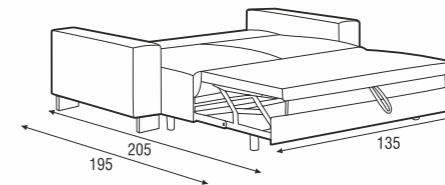

set 1 right / or left

2 seater 70 left / or right + chaiselongue 70 right / or left

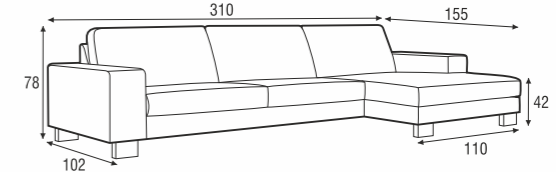

set 2 right / or left

3 seater 90 left / or right + chaiselongue 90 right / or left

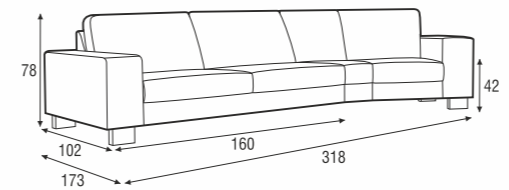

set 3 right / or left

2 seater 70 left / or right + corner 45° + armchair 70 right / or left

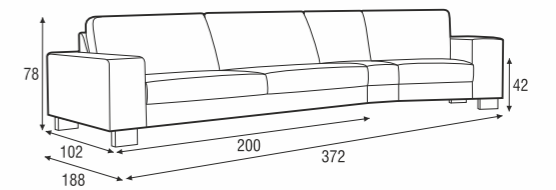

set 4 right / or left

3 seater 90 left / or right + corner 45° + armchair 90 right / or left

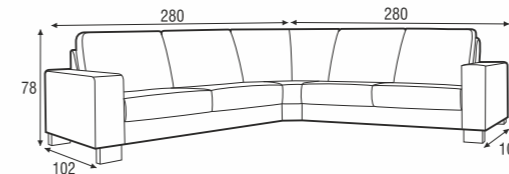

set 5

2 seater 70 left + corner 90° no.320 + 2 seater 70 right

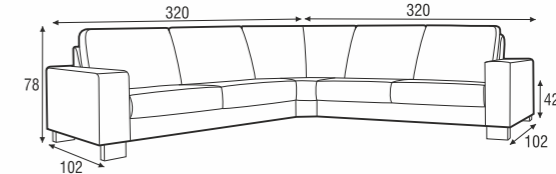

set 6

3 seater 90 left + corner 90° no.320 + 3 seater 90 right

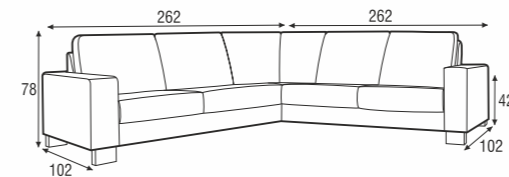

set 7

2 seater 70 left + corner 90° no.320 + 2 seater 70 right

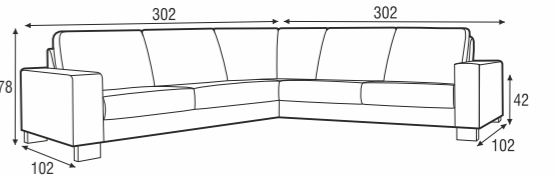

set 8

3 seater 90 left + corner 90° no.320 + 3 seater 90 right

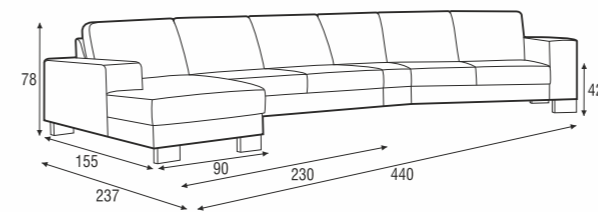

set 9 right / or left

chaiselongue 70 left / or right + 2 seater 70 without armrests + corner 45° + 2 seater 70 right / or left

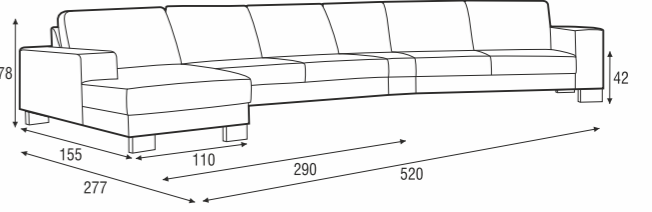

set 10 right / or left

chaiselongue 90 left / or right + 3 seater 90 without armrests + corner 45° + 3 seater 90 right / or left

>>quattro

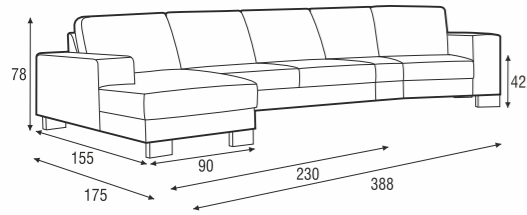

set 11 right / or left

chaiselongue 70 left / or right + 2 seater 70 without armrests + corner 45° + armchair 70 right / or left

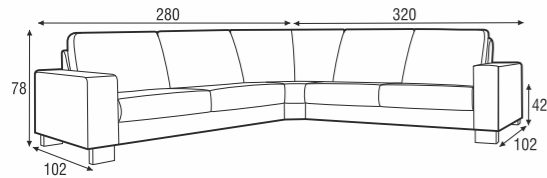

set 13 right / or left

3 seater 90 left / or right + corner 90° no.320 + 2 seater 70 right / or left

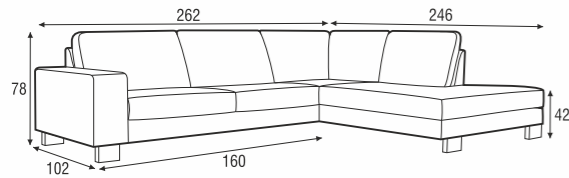

set 15 right / or left

2 seater 70 left / or right + corner 90° no.310 + bench 70 right / or left

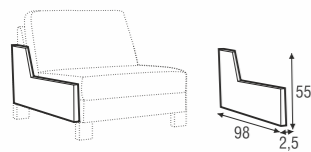

endpart left / or right
98x55x2,5

armrests

Drawings show combinations with armrest 460. Combinations with other armrest are properly shorter in width.

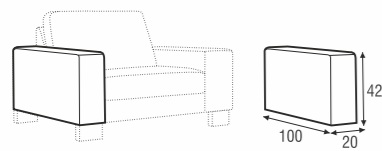

armrest 400
100x20x42

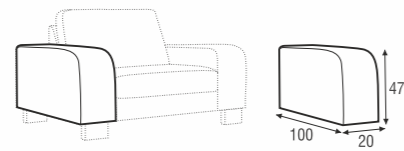

armrest 420
100x20x47

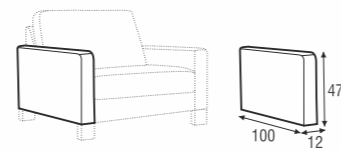

armrest 450
100x12x47

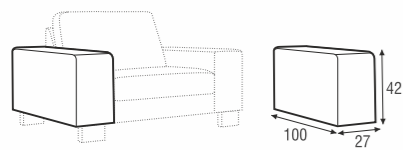

armrest 460
100x27x42

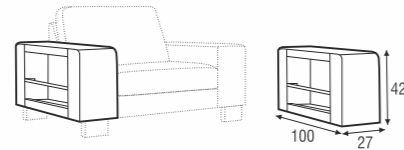

armrest 470
100x27x42

>>quattro

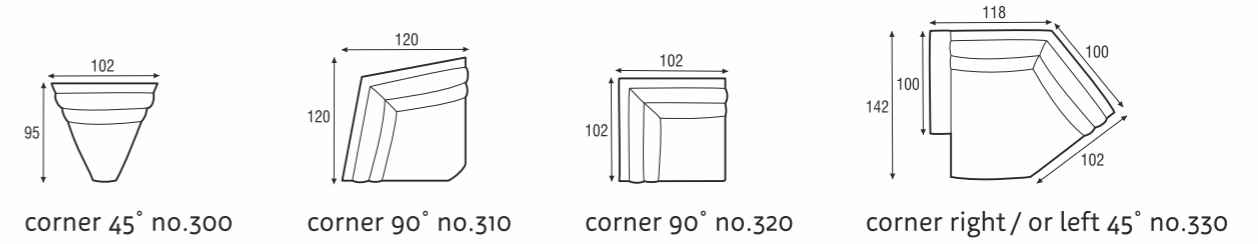

2 different comforts: standard or lux, 6 different armrests.

Available in fabric (standard or lux comfort) or leather (only standard comfort).

Rasmus

>page 86

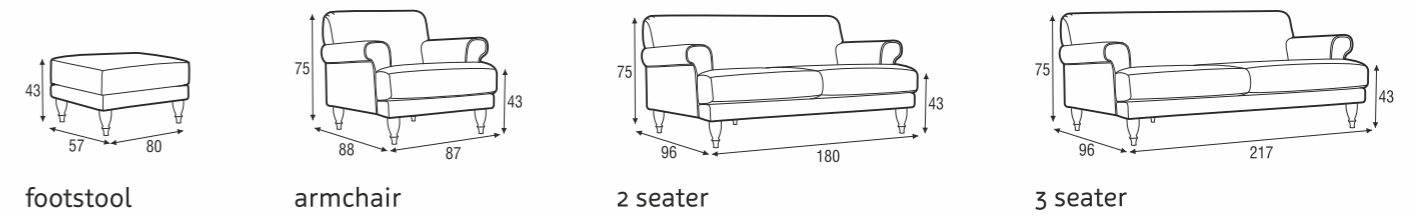

Stella

>page 92

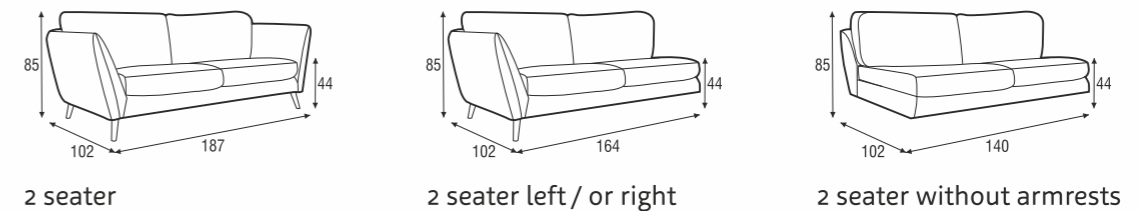
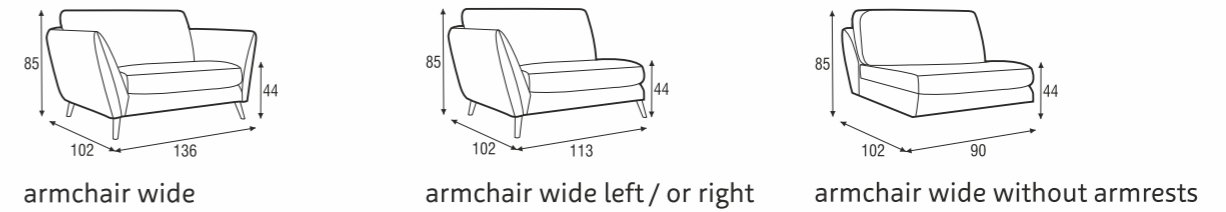
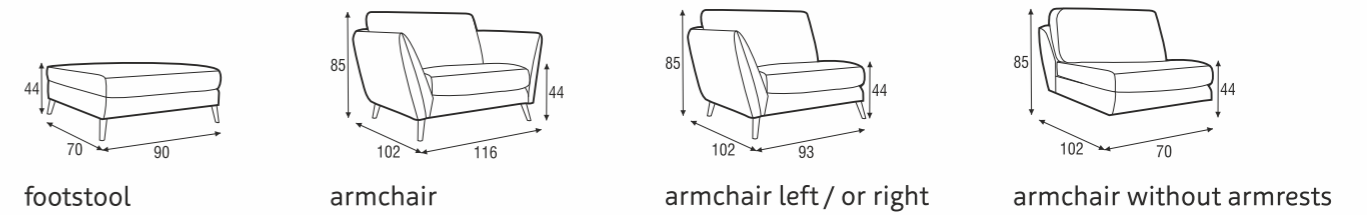

>>stella

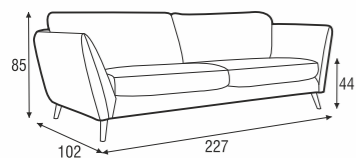

3 seater

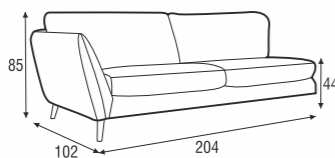

3 seater left/ or right

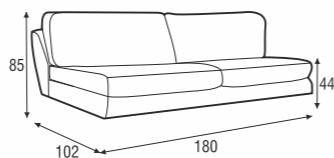

3 seater without armrests

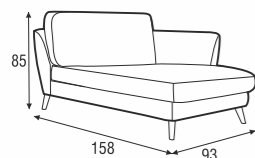

chaiselongue right / or left

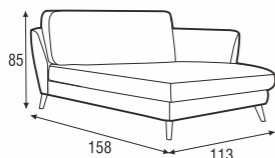

chaiselongue wide right / or left

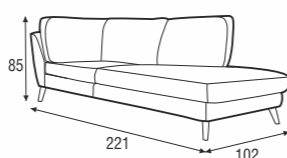

divan right / or left

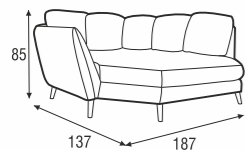

cozy corner left / or right

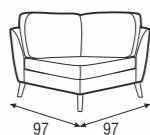

corner 90° no.1

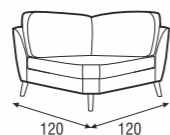

corner 90° no.2

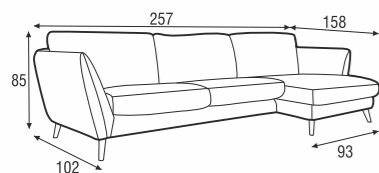

set 1 right / or left

2 seater left / or right + chaiselongue right / or left

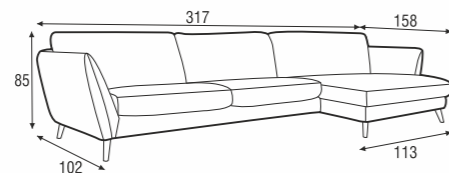

set 2 right / or left

3 seater left / or right + chaiselongue wide right / or left

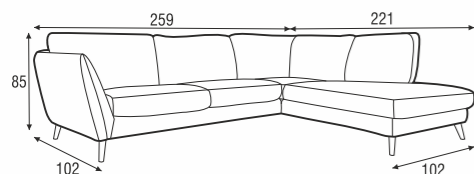

set 3 right / or left

2 seater left / or right + divan right / or left

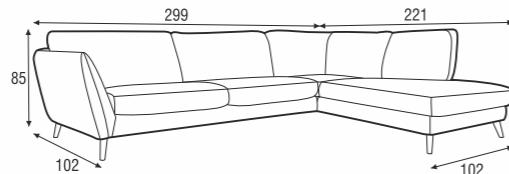

set 4 right / or left

3 seater left / or right + divan right / or left

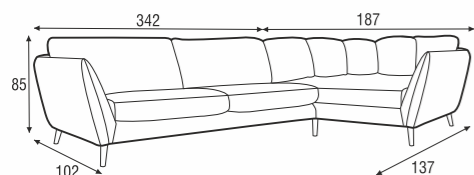

set 5 right / or left

3 seater left / or right + cozy corner right / or left

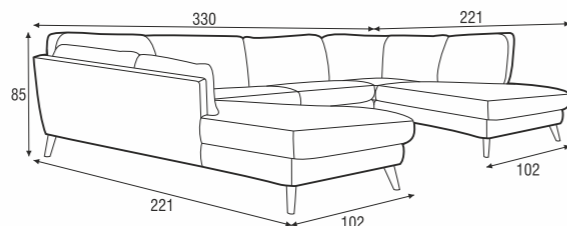

set 6

divan left + 2 seater without armrests + divan right

>>stella

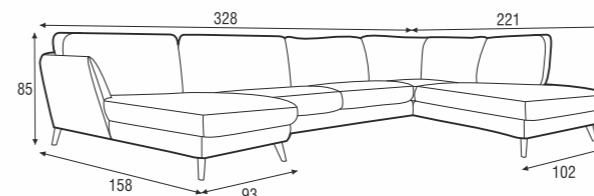

set 7 right / or left

chaiselongue left / or right + 2 seater without armrests + divan right / or left

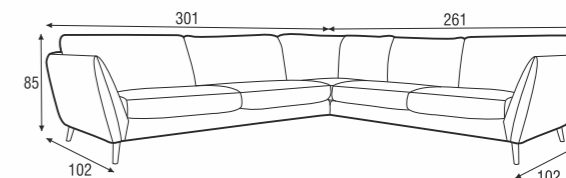

set 8 right / or left

3 seater left / or right + corner 90° no.1 + 2 seater right / or left

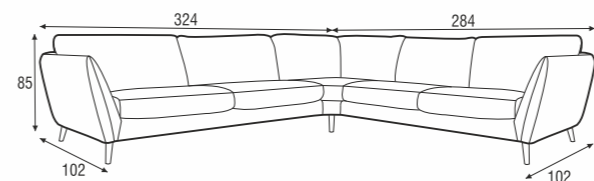

set 9 right / or left

3 seater left / or right + corner 90° no.2 + 2 seater right / or left

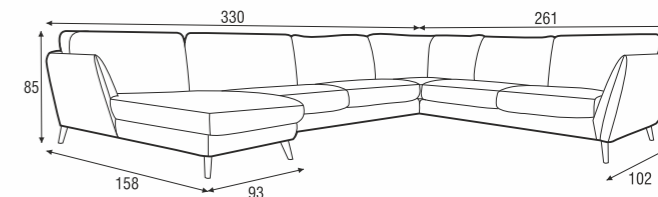

set 10 right / or left

chaiselongue left / or right + 2 seater without armrests + corner 90° no.1 + 2 seater right / or left

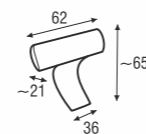

headrest L-62

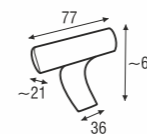

headrest L-77

Vario

>page 102

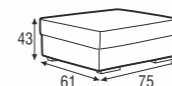

footstool
61x75

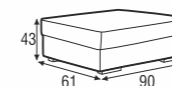

footstool wide
61x90

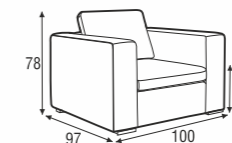

armchair

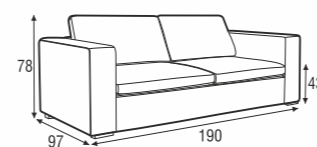

2 seater

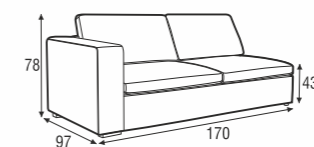

2 seater left / or right

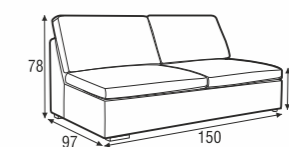

2 seater without armrest

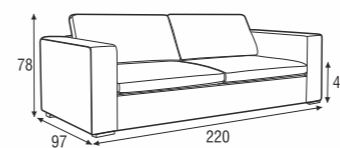

3 seater

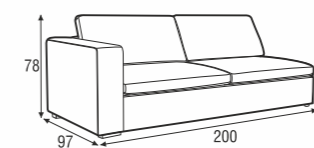

3 seater left / or right

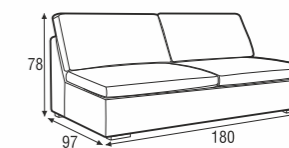

3 seater without armrest

>>vario

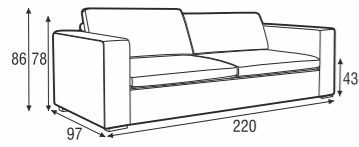

3 seater + back cushion with roll
available only with standard comfort

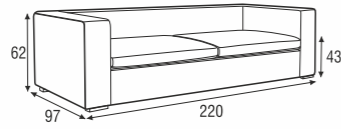

3 seater without back cushions

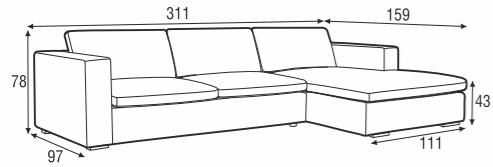

set 1 right / or left
chaiselongue wide right / or left + 3 seater left / or right

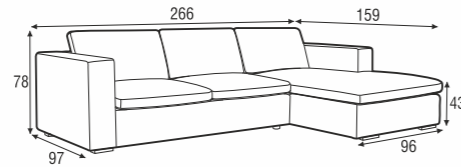

set 2 right / or left
chaiselongue right / or left + 2 seater left / or right

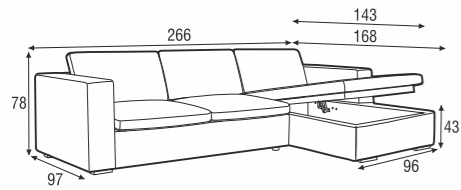

set 3 right / or left
available only in standard comfort
chaiselongue box right / or left + sofa bed left / or right
PAD 223x143 recommended

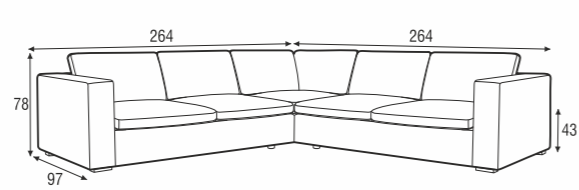

set 4
2 seater left + corner 90° + 2 seater right

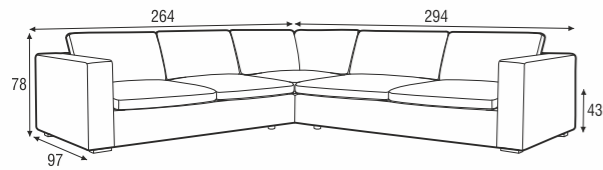

set 5 left / or right
2 seater left / or right + corner 90° + 3 seater right / or left

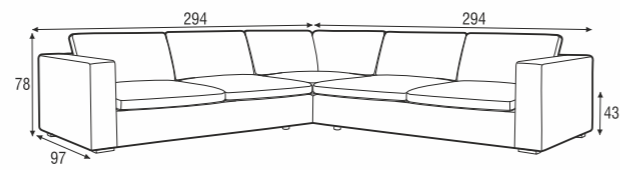

set 6
3 seater left + corner 90° + 3 seater right

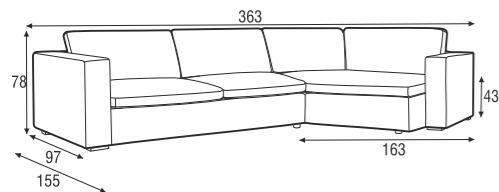

set 7 left / or right
3 seater left / or right + corner trapez right / or left

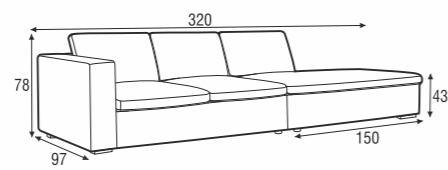

set 8 left / or right
2 seater left / or right + bench right / or left

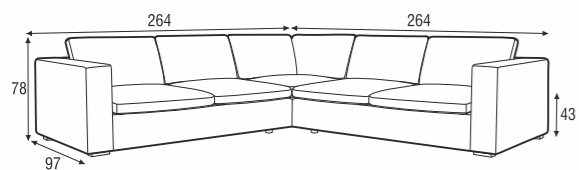

set 9 left / or right
available only in standard comfort
sofa bed left / or right + corner 90° + 2 seater right / or left
PAD 223x143 recommended

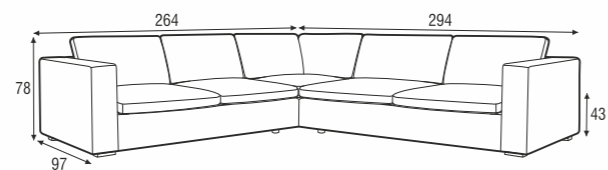

set 10 left / or right
available only in standard comfort
sofa bed left / or right + corner 90° + 3 seater right / or left
PAD 223x143 recommended

>>vario

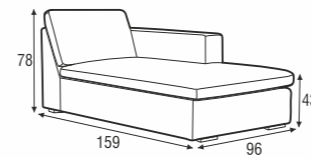

chaiselongue right / or left

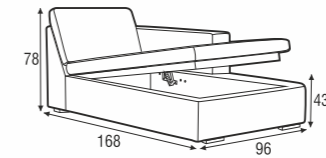

chaiselongue box right / or left

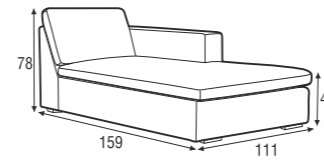

chaiselongue wide right / or left

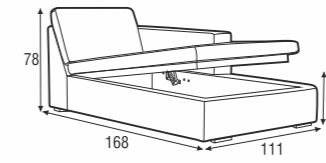

chaiselongue wide box right / or left

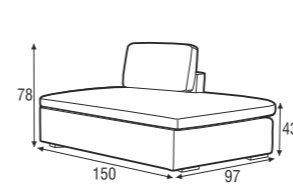

bench left / or right

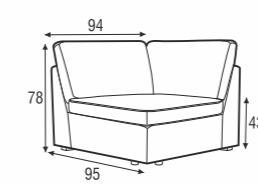

corner 90°

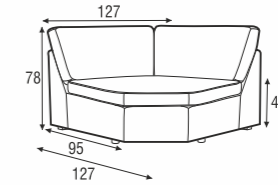

corner 135°

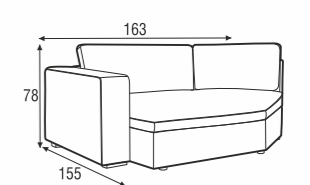

corner trapez left / or right

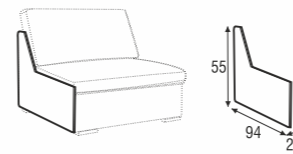

endpart



PAD

armrests

Drawings show combinations with armrest I.
Combinations with armrest II are properly shorter in width.

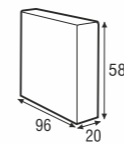

armrest I
20x96x58

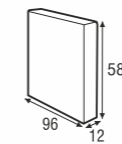

armrest II
12x96x58

cushions

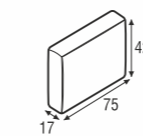

back cushion
75x42
2 seater; 2 seater left / or right
2 seater without armrests
chaiselongue
chaiselongue box; bench
set 2; set 3; set 8
sofa bed

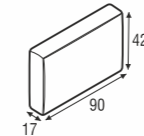

back cushion
90x42
3 seater; 3 seater left / or right
3 seater without armrests
chaiselongue wide
chaiselongue box wide
set 1

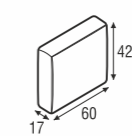

back cushion
60x42
armchair

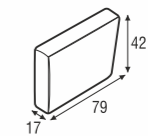

back cushion
79x42
corner trapez

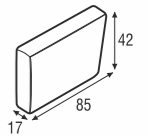

back cushion
85x42
corner trapez

>>vario

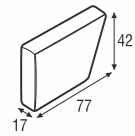

back cushion
77x42
corner 90°

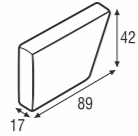

back cushion
89x42
corner 90°

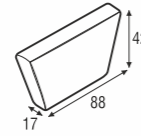

back cushion
88x42
corner 135°

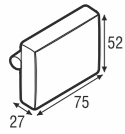

back cushion
with roll 75x52
2 seater; 2 seater left / or right
2 seater without armrests
chaiselongue
chaiselongue wide
chaiselongue box; bench
set 2; set 3; set 8
sofa bed

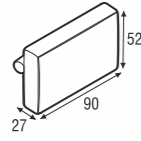

back cushion
with roll 90x52
3 seater; 3 seater left / or right
3 seater without armrests
chaiselongue wide
chaiselongue box wide
set 1

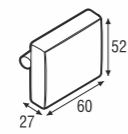

back cushion
with roll 60x52
armchair

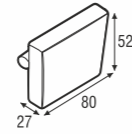

back cushion
with roll 80x52
corner trapez

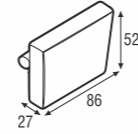

back cushion
with roll 86x52
corner trapez

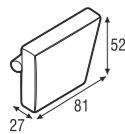

back cushion
with roll 81x52
corner 90°

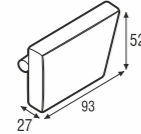

back cushion
with roll 93x52
corner 90°

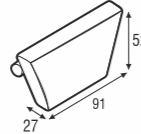

back cushion
with roll 91x52
corner 135°

Vario quilted

>page 102

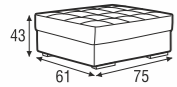

footstool
61x75

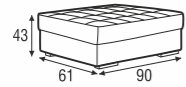

footstool wide
61x90

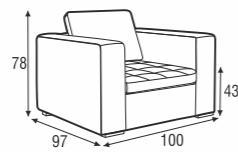

armchair

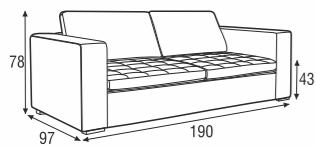

2 seater

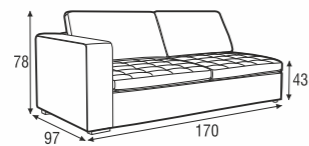

2 seater left / or right

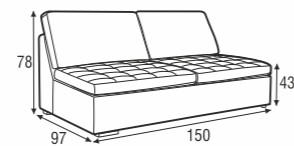

2 seater without armrest

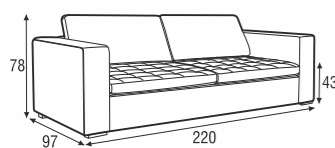

3 seater

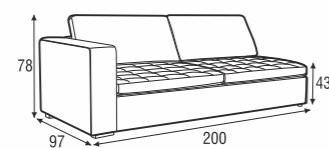

3 seater left / or right

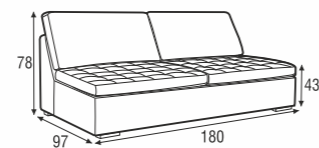

3 seater without armrest

>>vario quilted

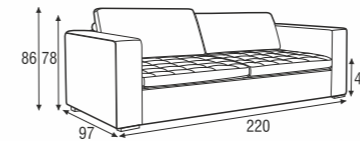

3 seater + back cushion with roll
available only with standard comfort

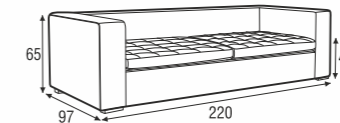

3 seater without back cushions

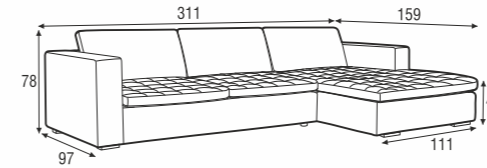

set 1 right / or left
chaiselongue wide right / or left + 3 seater left / or right

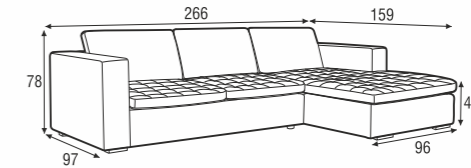

set 2 right / or left
chaiselongue right / or left + 2 seater left / or right

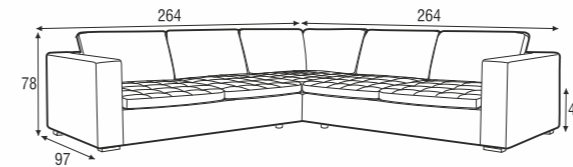

set 4
2 seater left + corner 90° + 2 seater right

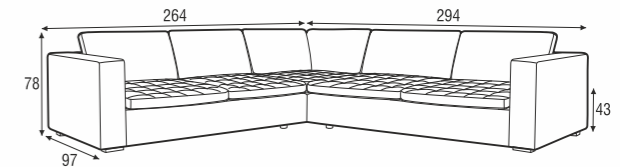

set 5 left / or right
2 seater left / or right + corner 90° + 3 seater right / or left

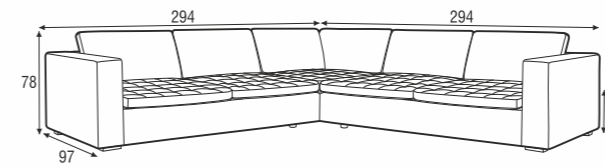

set 6
3 seater left + corner 90° + 3 seater right

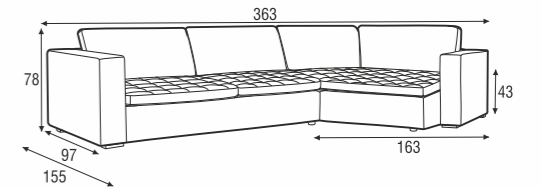

set 7 left / or right
3 seater left / or right + corner trapez right / or left

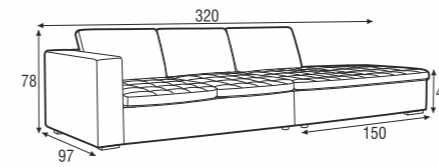

set 8 left / or right
2 seater left / or right + bench right / or left

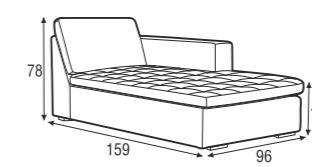

chaiselongue right / or left

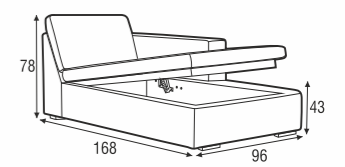

chaiselongue box right / or left

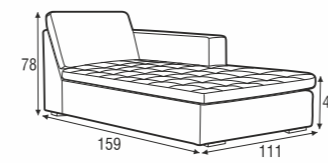

chaiselongue wide right / or left

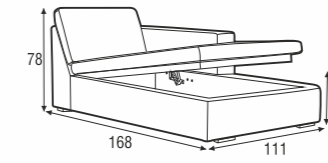

chaiselongue wide box right / or left

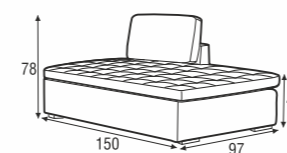

bench right / or left

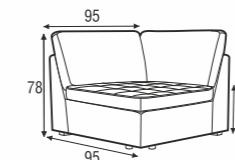

corner 90°

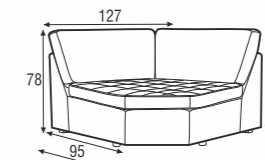

corner 135°

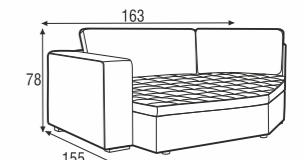

corner trapez left / or right

>>vario quilted

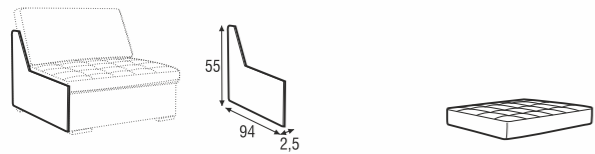

endpart

seat cushion
with quilting

armrests

Drawings show combinations with armrest I.
Combinations with armrest II are properly shorter in width.



armrest I
20x96x58

armrest II
12x96x58

cushions

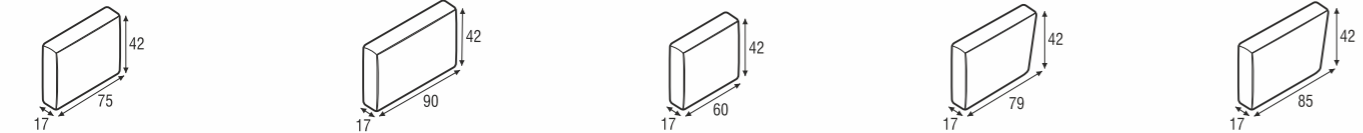

back cushion
75x42

2 seater; 2 seater left / or right
2 seater without armrests
chaiselongue
chaiselongue box; bench
set 2; set 8

back cushion
90x42

3 seater; 3 seater left / or right
3 seater without armrests
chaiselongue wide
chaiselongue box wide
set 1

back cushion
60x42

armchair

back cushion
79x42

corner trapez

back cushion
85x42

corner trapez

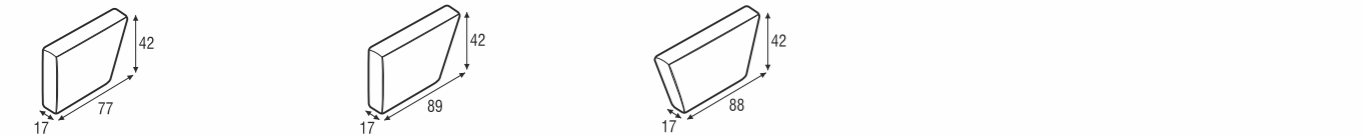

back cushion
77x42

corner 90°

back cushion
89x42

corner 90°

back cushion
88x42

corner 135°

back cushion
with roll 80x52

corner trapez

back cushion
with roll 86x52

corner trapez

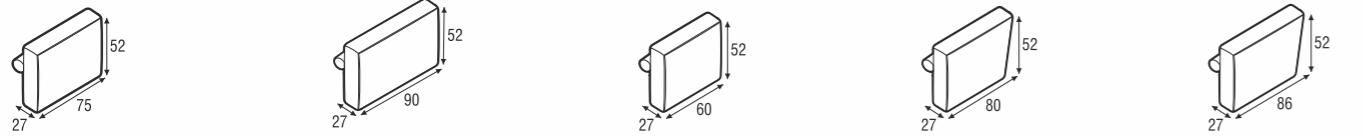

back cushion
with roll 75x52

2 seater; 2 seater left / or right
2 seater without armrests
chaiselongue
chaiselongue box; bench
set 2; set 8

back cushion
with roll 90x52

3 seater; 3 seater left / or right
3 seater without armrests
chaiselongue wide
chaiselongue box wide
set 1

back cushion
with roll 60x52

armchair

back cushion
with roll 80x52

corner trapez

back cushion
with roll 86x52

corner trapez

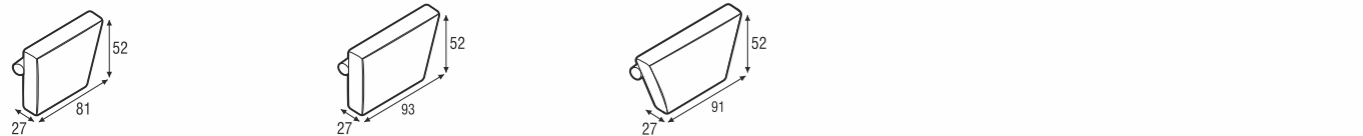

back cushion
with roll 81x52

corner 90°

back cushion
with roll 93x52

corner 90°

back cushion
with roll 91x52

corner 135°



Venezia

>page 128

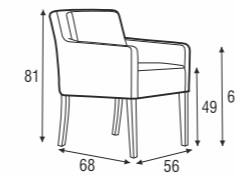

armchair

Available in fabric or leather.

Viggo

>page 130

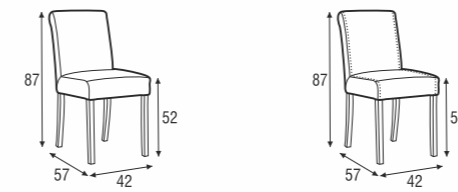

chair

chair

leather cover

Available in fabric or leather.



Vincent

>page 94

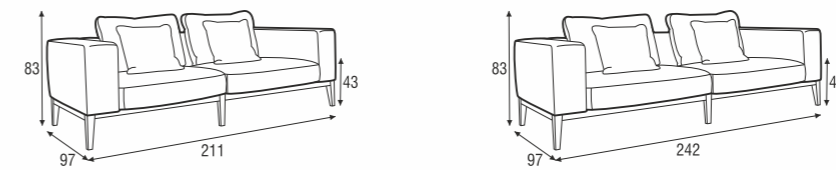

2,5 seater

3 seater



Watson

>page 127

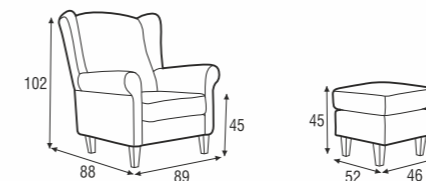

armchair

footstool





tea & *book*

Abbe

>page 168

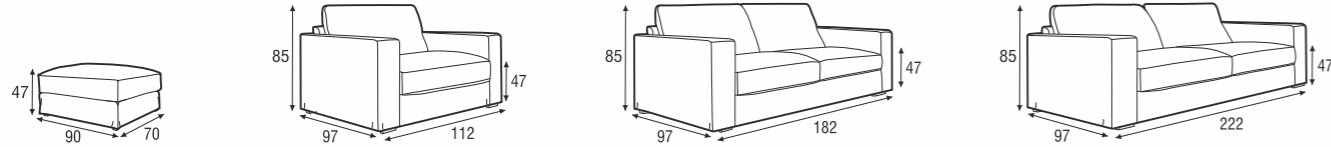

footstool 70x90 armchair 2 seater 3 seater

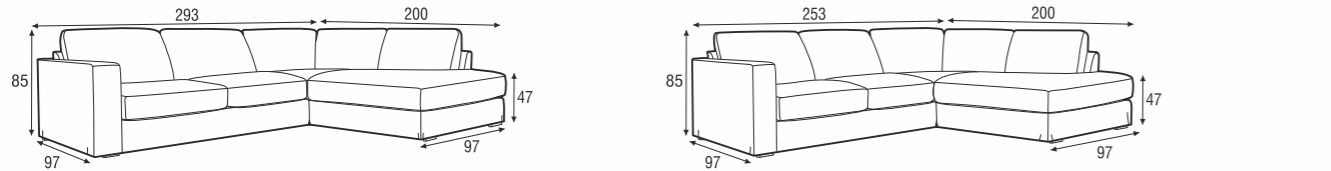

set 1 right / or left
divan right / or left + 3 seater left / or right

set 2 right / or left
divan right / or left + 2 seater left / or right

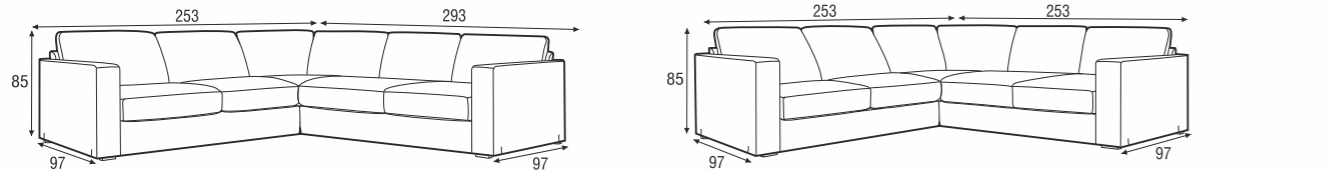

set 3 right / or left
2 seater right / or left + corner 90° + 3 seater left / or right

set 4
2 seater left + corner 90° + 2 seater right

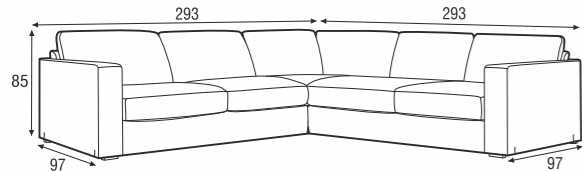

set 5
3 seater left + corner 90° + 3 seater right

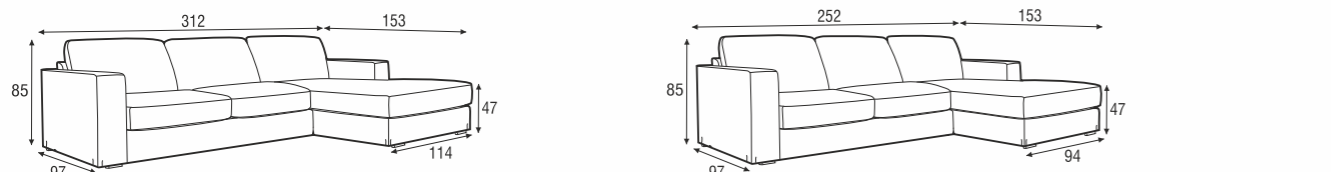

set 6 right / or left
chaiselounge wide left / or right + 3 seater left / or right

set 7 left / or right
chaiselounge left / or right + 2 seater left / or right

cushion

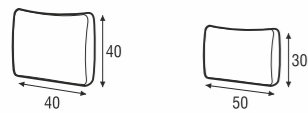

cushion 40x40 cushion 45x30

Alaska

>page 166

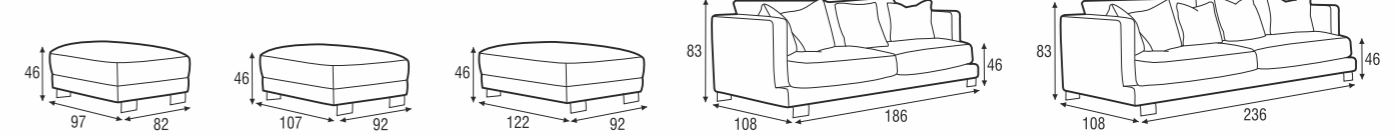

footstool footstool footstool 2 seater 3 seater or 3 seater / two parts

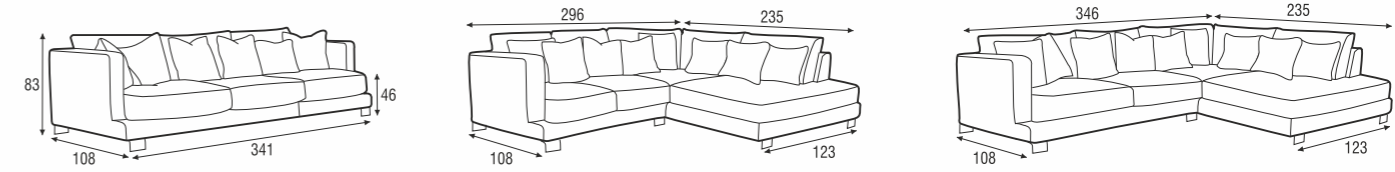

set 1
3 seater left/or right + armchair wide right/ or left

set 2 right / or left
2 seater left / or right + divan right / or left

set 3 right / or left
3 seater left / or right + divan right / or left

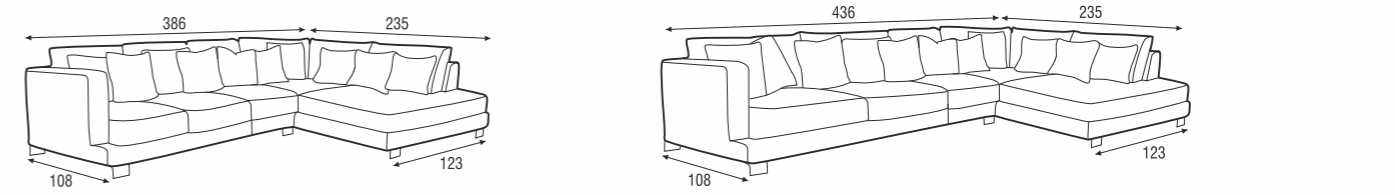

set 4 right / or left
2 seater left / or right + armchair without armrests + divan right / or left

set 5 right / or left
3 seater left / or right + armchair without armrests + divan right / or left

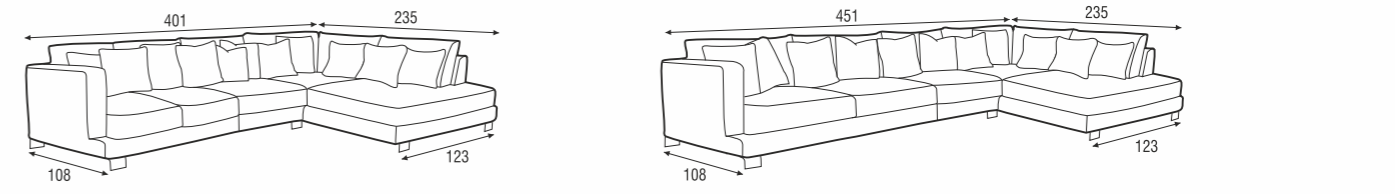

set 6 right / or left
2 seater left / or right + armchair wide without armrests + divan right / or left

set 7 right / or left
3 seater left / or right + armchair wide without armrests + divan right / or left

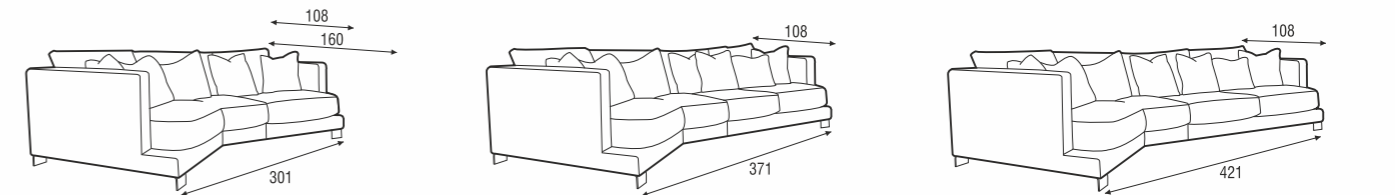

set 8 left / or right
corner 35° left / or right + armchair right / or left

set 9 left / or right
corner 35° left / or right + 2 seater right / or left

set 10 left / or right
corner 35° left / or right + 3 seater right / or left

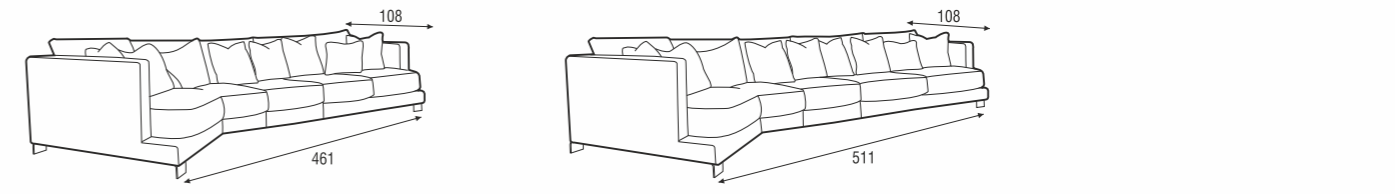

set 11 left / or right
corner 35° left / or right + armchair without armrests + 2 seater right / or left

set 12 left / or right
corner 35° left / or right + armchair without armrests + 3 seater right / or left

>>alaska

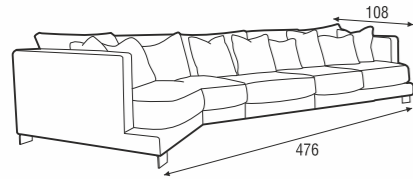

set 13 left / or right

corner 35° left / or right + armchair wide without armrests + 2 seater right / or left

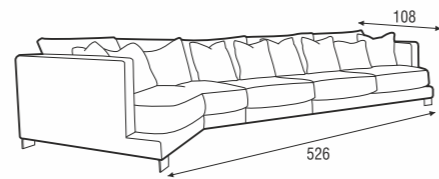

set 14 left / or right

corner 35° left / or right + armchair wide without armrests + 3 seater right / or left

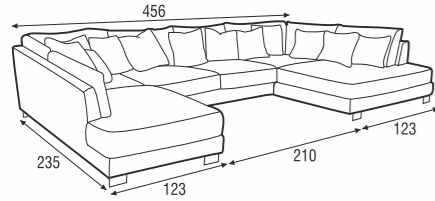

set 15

divan left + 3 seater without armrest + divan right

Brandon

>page 162

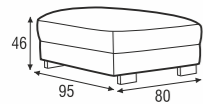

footstool 95x80

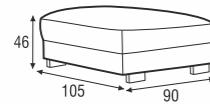

footstool 105x90

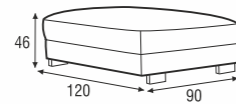

footstool 120x90

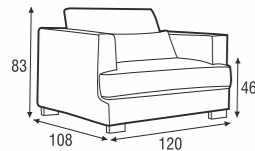

armchair

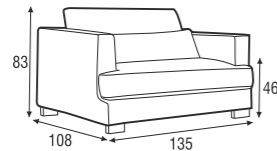

armchair wide

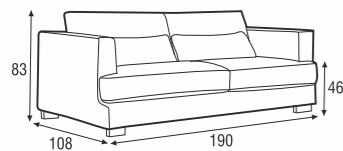

2 seater

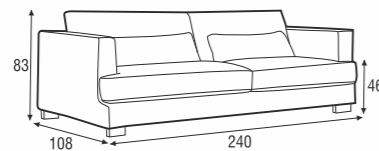

3 seater or 3 seater / two parts

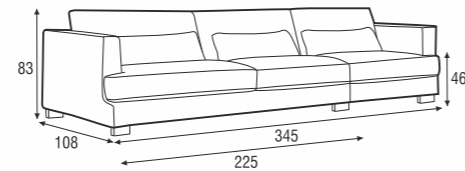

set 1

3 seater left + armrest wide right

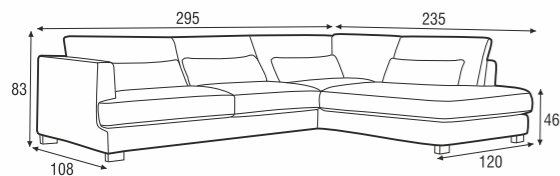

set 2 right / or left

2 seater left / or right + divan right / or left

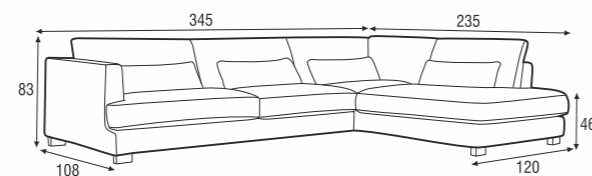

set 3 right / or left

3 seater left / or right + divan right / or left

>>brandon

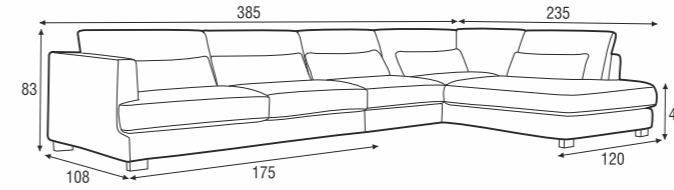

set 4 right / or left

2 seater left / or right + armchair without armrests + divan right / or left

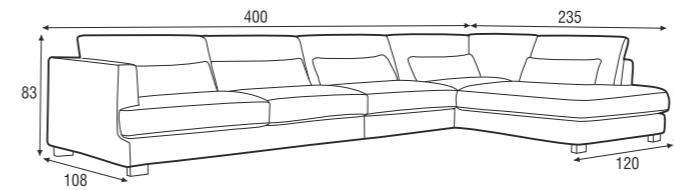

set 6 right / or left

2 seater left / or right + armchair wide without armrests + divan right / or left

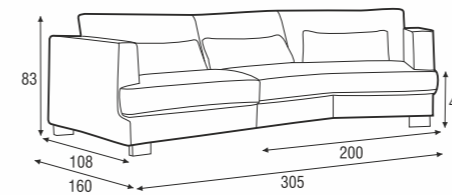

set 8 right / or left

armchair left / or right + corner 35° right / or left

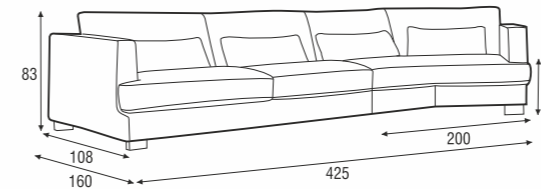

set 10 right / or left

3 seater left / or right + corner 35° right / or left

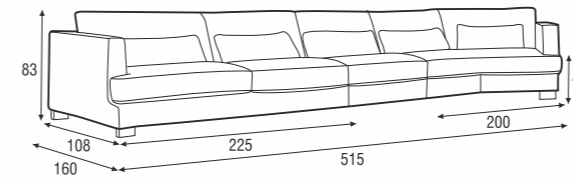

set 12 right / or left

3 seater left / or right + armchair without armrests + corner 35° right / or left

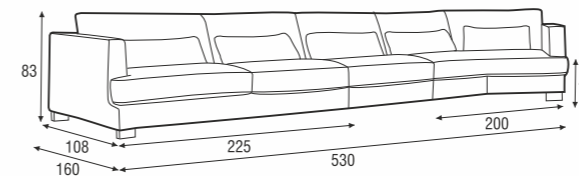

set 14 right / or left

3 seater left / or right + armchair wide without armrests + corner 35° right / or left

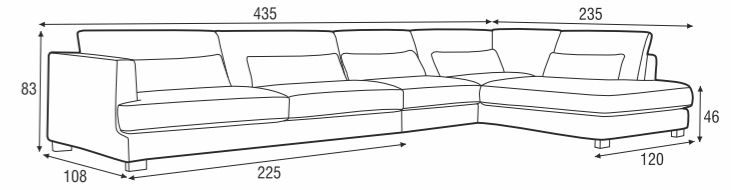

set 5 right / or left

3 seater left / or right + armchair without armrests + divan right / or left

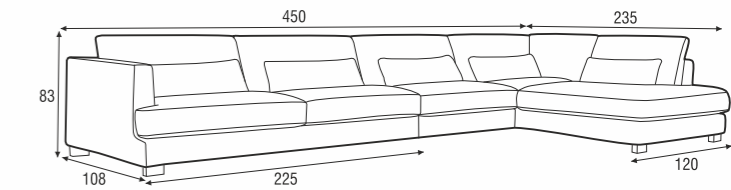

set 7 right / or left

3 seater left / or right + armchair wide without armrests + divan right / or left

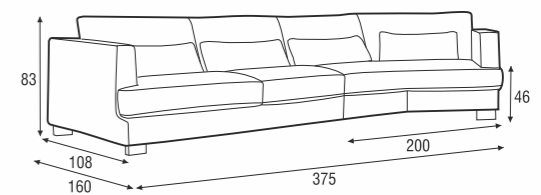

set 9 right / or left

2 seater left / or right + corner 35° right / or left

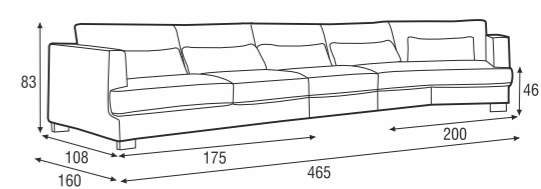

set 11 right / or left

2 seater left / or right + armchair without armrests + corner 35° right / or left

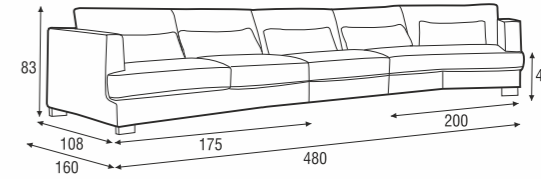

set 13 right / or left

2 seater left / or right + armchair wide without armrests + corner 35° right / or left

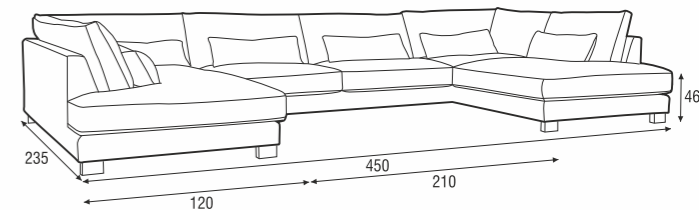

set 15

divan left + 3 seater without armrests + divan right

Cloud

>page 164

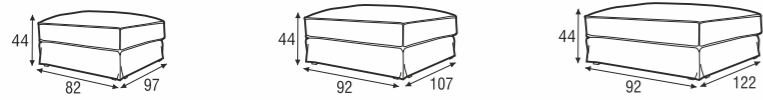

footstool 97x82 footstool 107x92 footstool 122x92

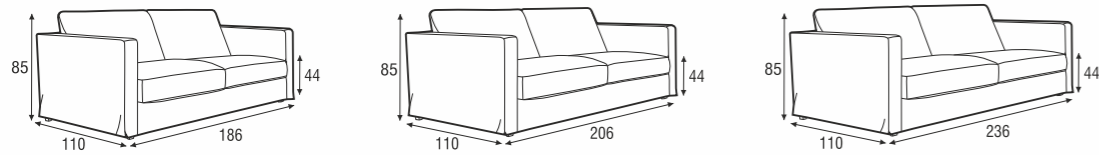

2 seater 2,5 seater 3 seater or 3 seater / two parts

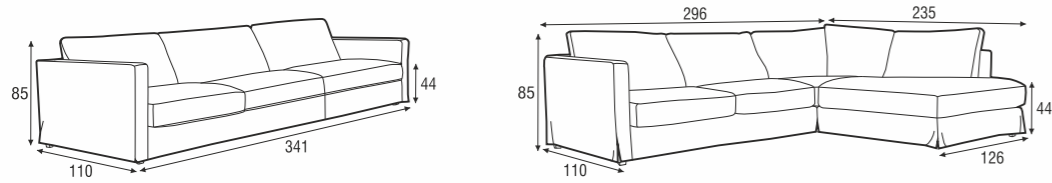

set 1
3 seater left + armchair wide right

set 2 right / or left
2 seater left / or right + divan right / or left

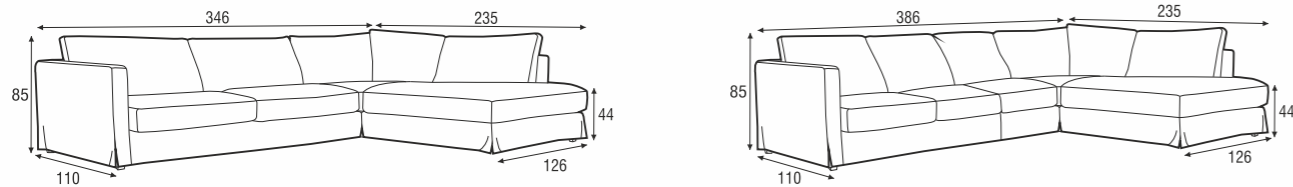

set 3 right / or left
3 seater left / or right + divan right / or left

set 4 right / or left
2 seater left / or right + armchair without armrests + divan right / or left

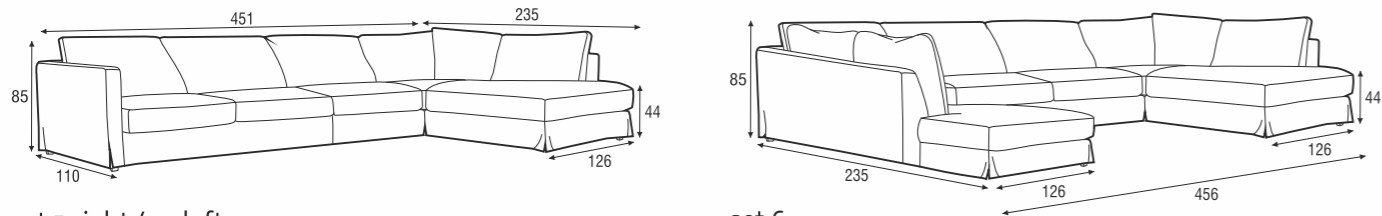

set 5 right / or left
3 seater left / or right + armchair wide without armrests + divan right / or left

set 6
divan left + 3 seater without armrests + divan right

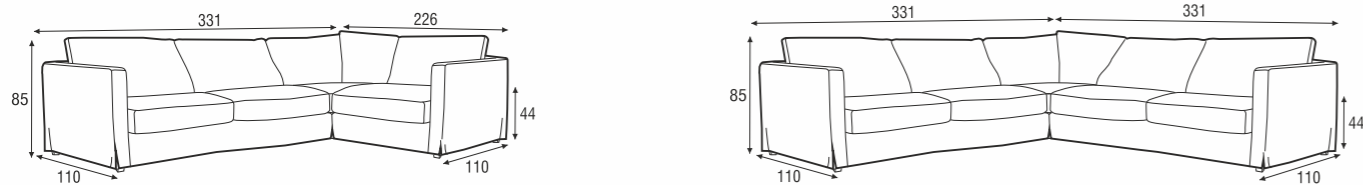

set 7 right / or left
3 seater left / right + corner 90° + armchair wide right / or left

set 8
3 seater left + corner 90° + 3 seater right

>>cloud

cushions



cushion 40x40 cushion 50x30

Deco cushions: 50x30 cm and 40x40 cm must be ordered separately.

Colorado

>page 160

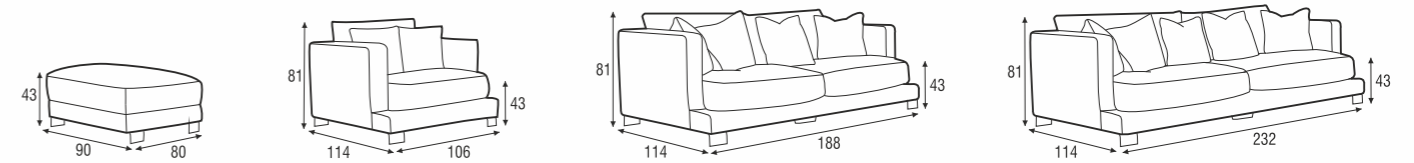

footstool armchair 2 seater 3 seater / two parts



set 1
4 seater / two parts

set 2
divan left + 2 seater without armrest + divan right

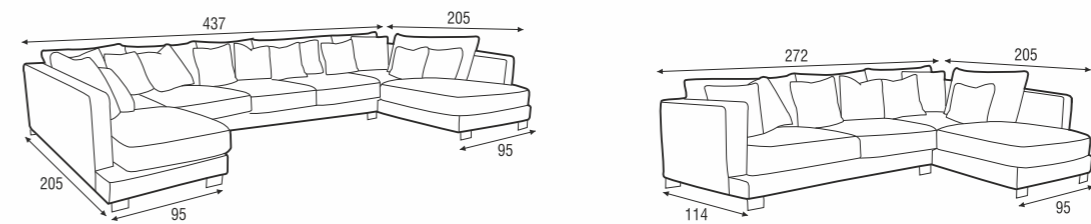

set 3 right / or left
2 seater left / or right + divan right / or left

set 4 right / or left
4 seater / two parts left / or right + divan right / or left

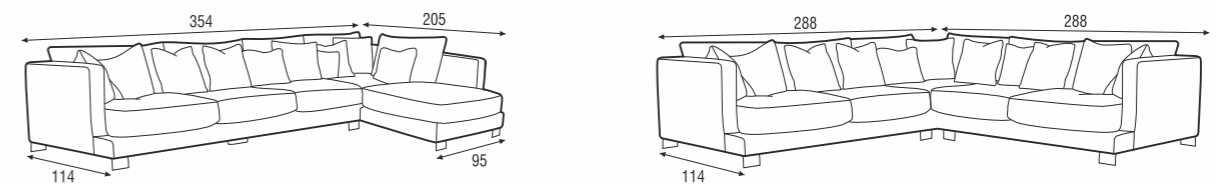

set 5
2 seater left + corner 90° + 2 seater right

Fatty

>page 180

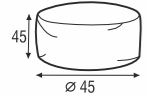

footstool Ø45

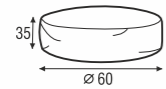

footstool Ø60

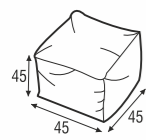

footstool 45x45x45

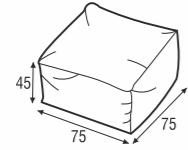

footstool 75x75x45

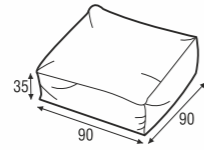

footstool 90x90x35

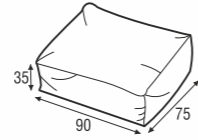

footstool 90x75x35

Available in fabric or leather.

Heaven

>page 174

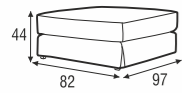

footstool

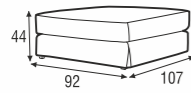

footstool

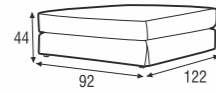

footstool

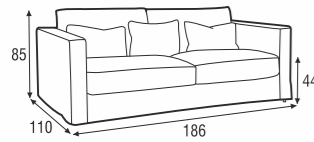

2 seater

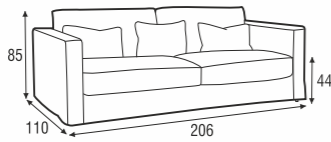

2,5 seater

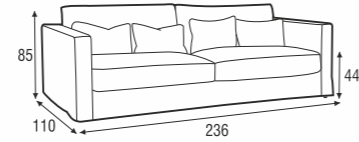

3 seater or 3 seater / two parts

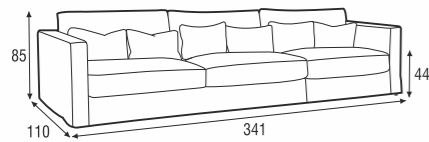

set 1

3 seater left / or right + armchair wide right / or left

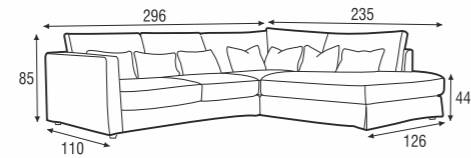

set 2 right / or left

2 seater left / or right + divan right / or left

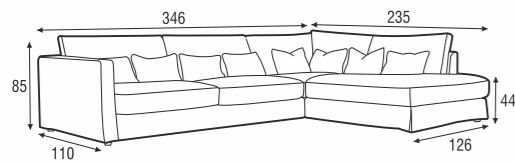

set 3 right / or left

3 seater left / or right + divan right / or left

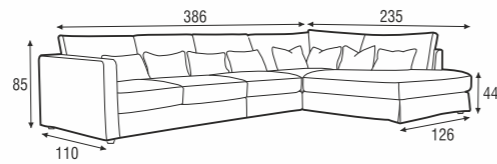

set 4 right / or left

2 seater left / or right + armchair without armrest + divan right / or left

>>haeven

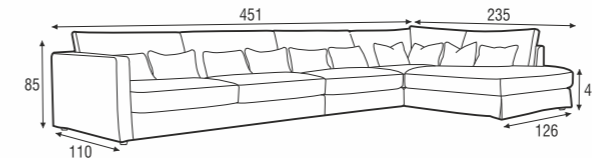

set 5 right / or left

3 seater left / or right + armchair wide without armrest + divan right / or left

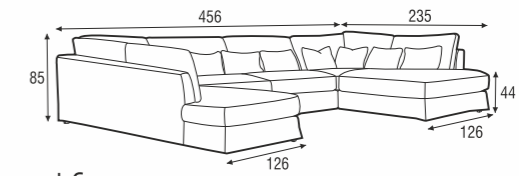

set 6

divan left + 3 seater without armrest + divan right

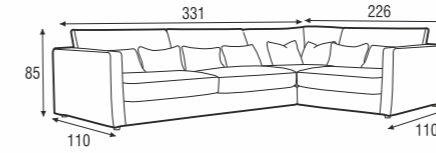

set 7 right / or left

3 seater left / or right + corner 90° + armchair wide right / or left

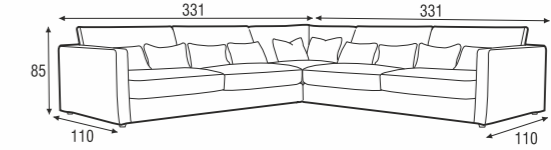

set 8

3 seater left + corner 90° + 3 seater right

Julia

>page 148, 150

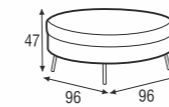

footstool

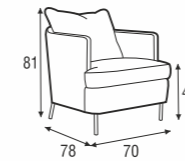

armchair

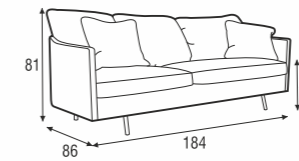

2 seater

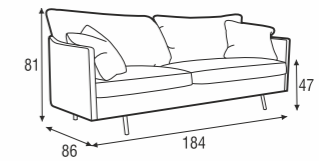

2 seater with big cushions

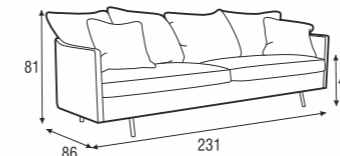

3 seater

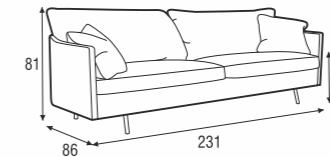

3 seater with big cushions

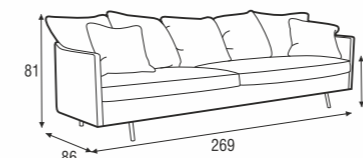

4 seater stright / two parts

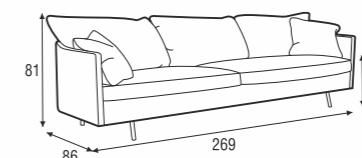

4 seater stright / two parts with big cushions

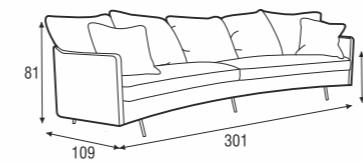

4 seater round / two parts

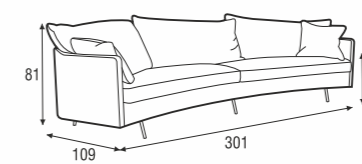

4 seater round / two parts with big cushions

>>julia

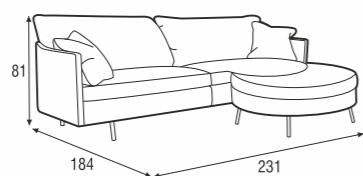
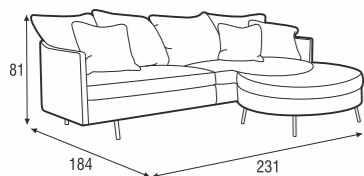

set 1 right / or left
3 seater element round right / or left + footstool

set 1 right / or left with big cushions
3 seater element round right / or left + footstool

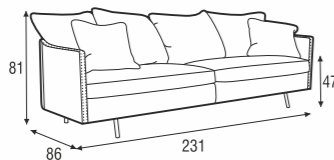
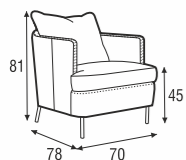

armchair
leather cover

3 seater
leather cover

Available in fabric or leather.

Kajsa

>page 176

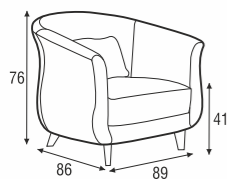

armchair

Contrast piping available.

Lena

>page 152

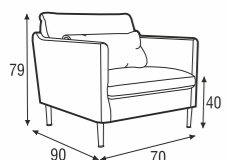

armchair

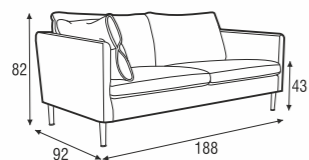

2 seater ver.A

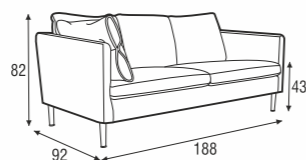

2 seater ver.C

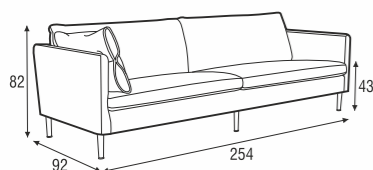

set 1 ver.A
element left + element right

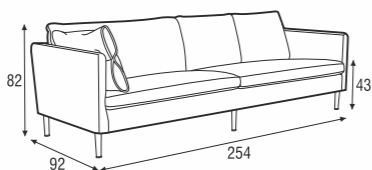

set 1 ver.B
element left + element right

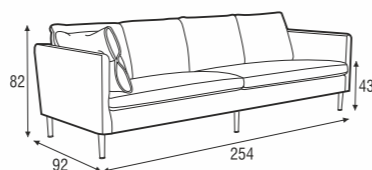

set 1 ver.C
element left + element right

>>lena

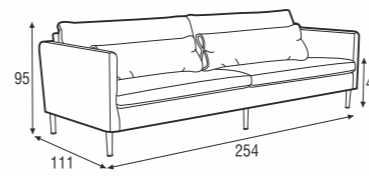

set 2 deep ver.A
element deep left + element deep right

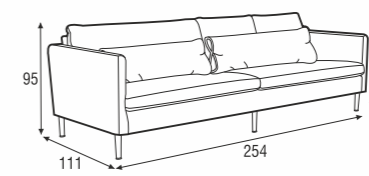

set 2 deep ver.B
element deep left + element deep right

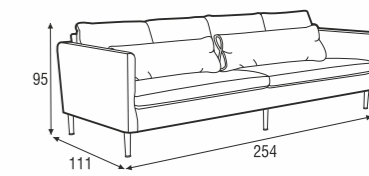

set 2 deep ver.C
element deep left + element deep right

cushions

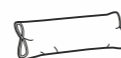

low back cushion
element deep



armrest cushion

The detail can be chosen in different color.

Leo

>page 144

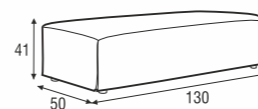

footstool

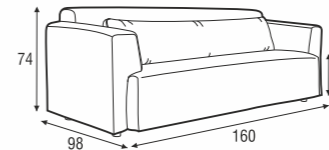

love seat

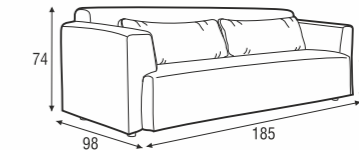

2 seater

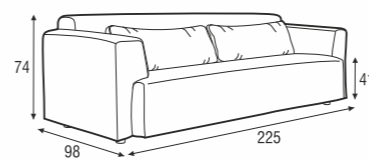

3 seater

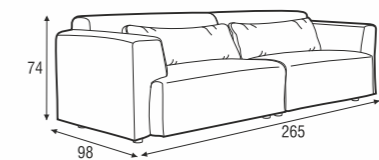

4 seater two parts

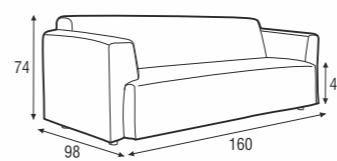

love seat without back cushion

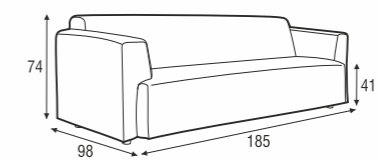

2 seater without back cushions

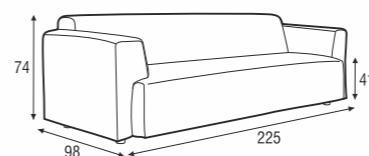

3 seater without back cushions

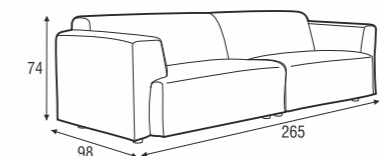

4 seater two parts without back cushions

>>leo

cushions

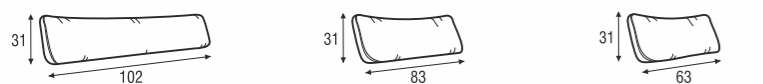

cushion 102x31 2x for 4 seater two parts 1x for love seat
cushion 83x31 2x for 3 seater
cushion 63x31 2x for 2 seater

Lily

>page 154

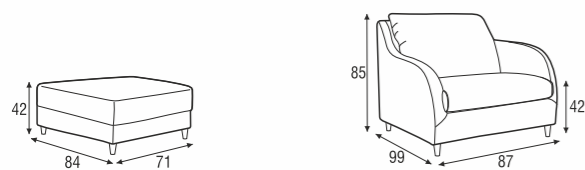

footstool 84x71x42
armchair 99x87x85x42

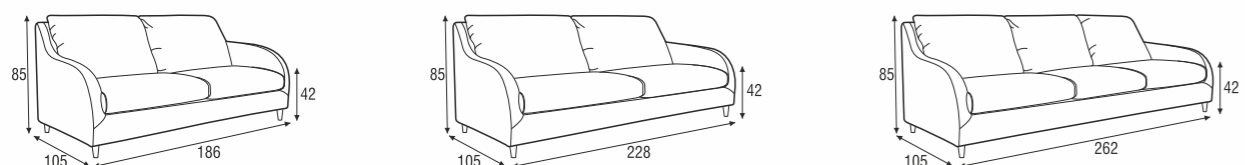

2 seater 105x186x85x42
3 seater 105x228x85x42
4 seater or 4 seater / two parts 105x262x85x42

Available in fabric or leather.

Linda

>page 172

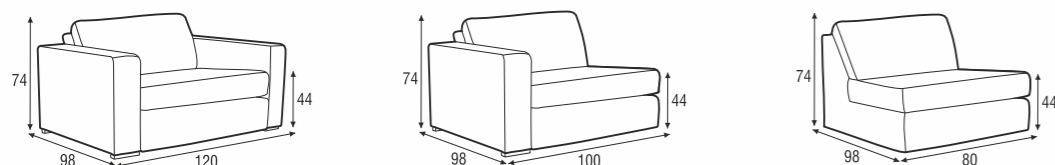

element 80 98x120x74x44
element 80 left / or right 98x100x74x44
element 80 without armrests 98x80x74x44

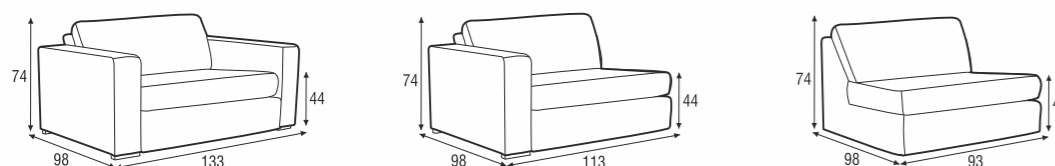

element 93 98x133x74x44
element 93 left / or right 98x113x74x44
element 93 without armrests 98x93x74x44

>>linda

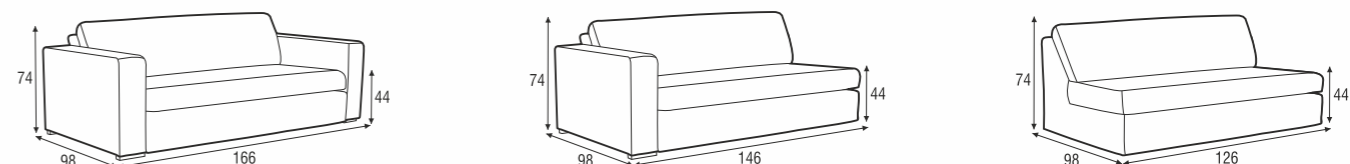

element 126 98x166x74x44
element 126 left / or right 98x146x74x44
element 126 without armrests 98x126x74x44

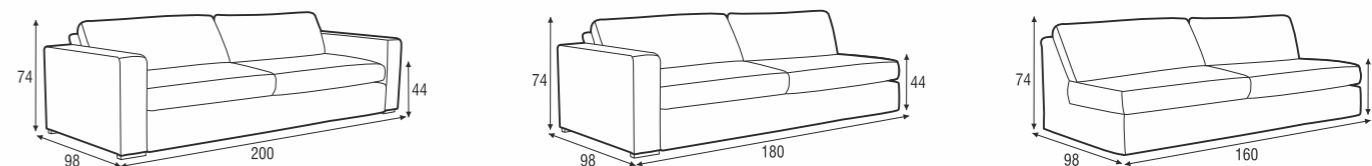

2,5 seater 98x200x74x44
2,5 seater left / or right 98x180x74x44
2,5 seater without armrests 98x160x74x44

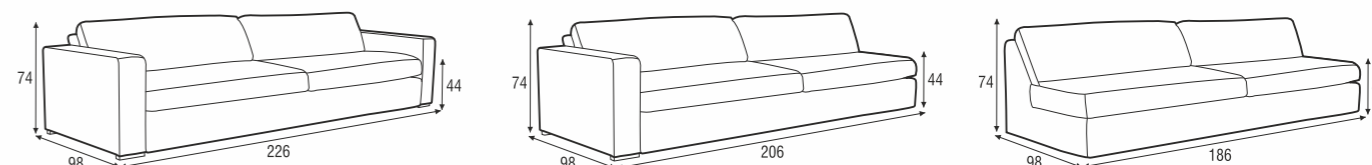

3 seater 98x226x74x44
3 seater left / or right 98x206x74x44
3 seater without armrests 98x186x74x44

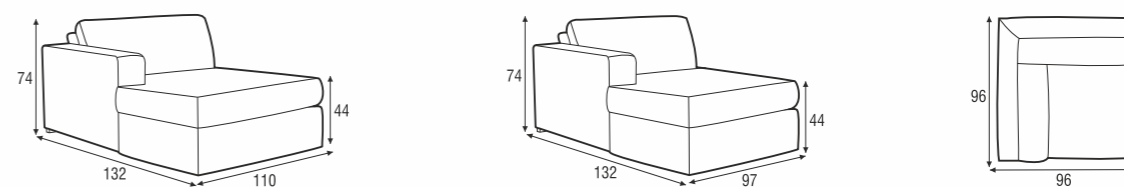

chaiselongue 93 left / or right 132x110x74x44
chaiselongue 80 left / or right 132x97x74x44
corner 90° 96x96x96

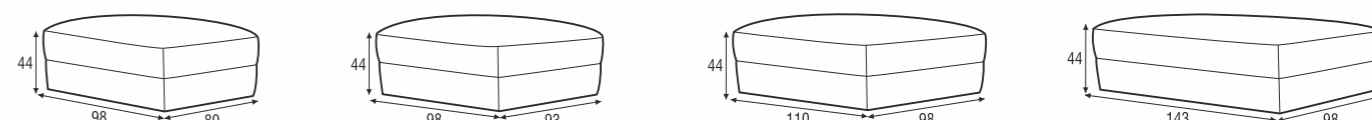

footstool 80x98 98x80x44
footstool 93x98 98x93x44
footstool 110x98 110x98x44
footstool 143x98 143x98x44

Unlimited possibilities of combinations, below example arrangements.

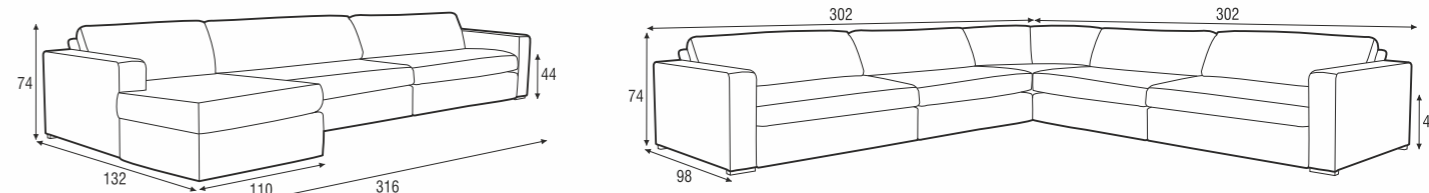

set right / or left 132x110x316x74x44
chaiselongue 93 left / or right + 3 seater right / or left
set 302x302x74x44
3 seater left + corner 90° + 3 seater right

>>linda

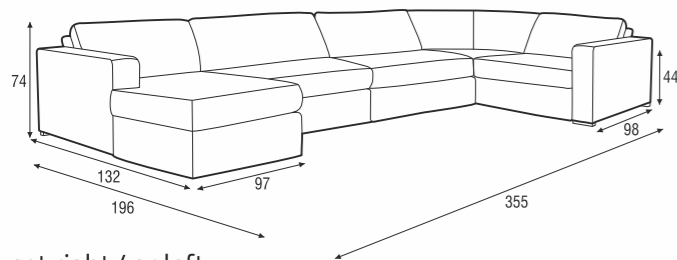

set right / or left

chaiselougne 80 left / or right + 2,5 seater without armrests + corner 90° + element 80 right / or left

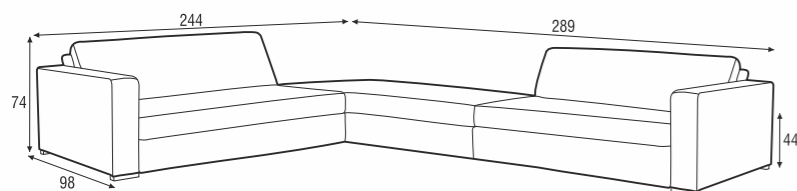

set right / or left

element 126 left + footstool 143 + element 126 right

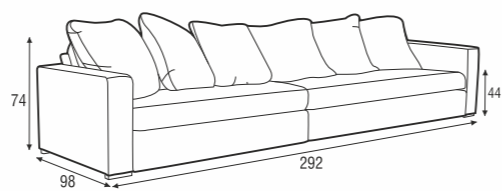

example with cushions

element 126 left + element 126 right + 4x cushions 55x55 + 2x cushions 60x60

armrest

All elements fully upholstered - can exist with or without armrest
Movable armrest at any time
Universal for all elements and purposes (left and right)

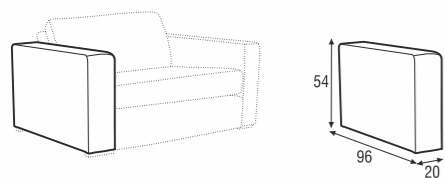

cushions



back cushion
40x40

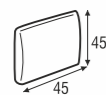

back cushion
45x45

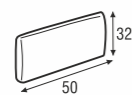

back cushion
50x32

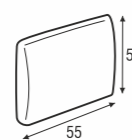

back cushion
55x55

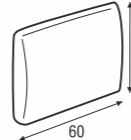

back cushion
60x60

Mia

>page 178

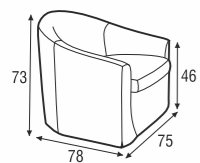

armchair



New York

>page 170

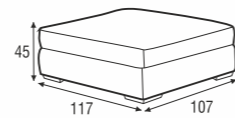

footstool



3 seater XL / two parts

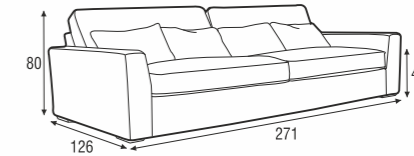

4 seater XL / two parts

Oscar

>page 156



Modular system - unlimited set arrangements.

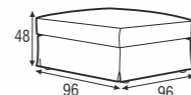

footstool

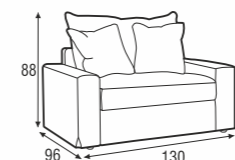

armchair

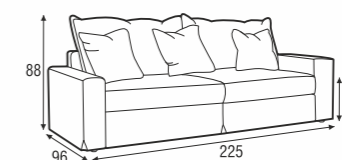

3 seater

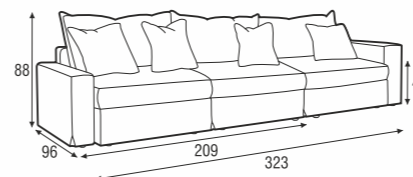

set 1 left / or right

3 seater left / or right + armchair right / or left

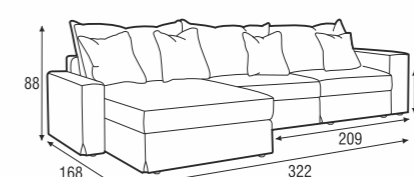

set 2 left / or right

chaiselongue left / or right + 3 seater right / or left

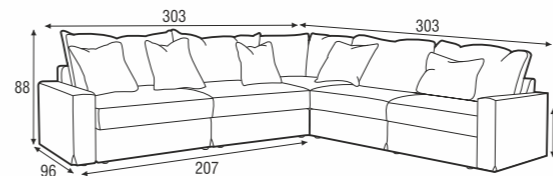

set 3

3 seater left + corner 90° + 3 seater right

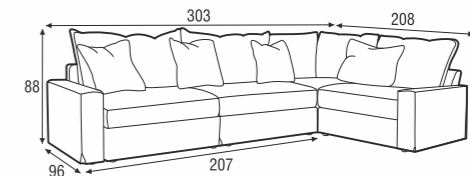

set 4 left / or right

3 seater left / or right + corner 90° + armchair right / or left

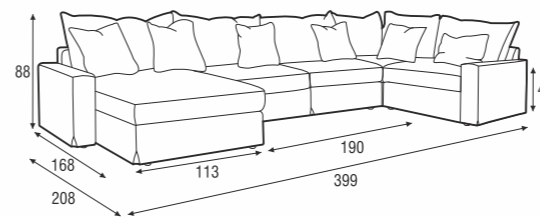

set 5 left / or right

chaiselongue left / or right + 3 seater without armrests + corner 90° + armchair right / or left

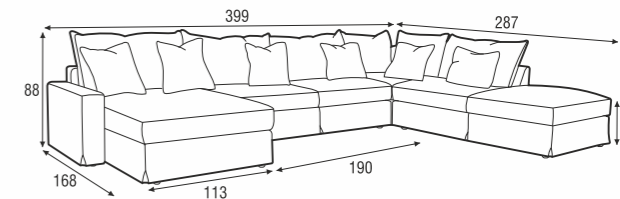

set 6 left / or right

chaiselongue left / or right + 3 seater without armrests + corner 90° + armchair without armrests + footstool

>>oscar

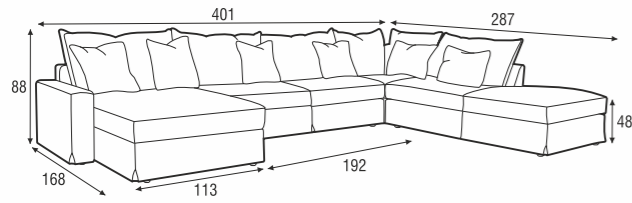

set 7 left / or right

chaiselongue left / or right + 2x armchair without armrests + corner 90° + armchair without armrests + footstool

Deco cushions: 50x30 cm and 40x40 cm must be ordered separately.

Rose

>page 158

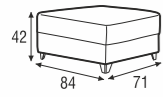

footstool

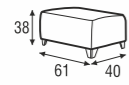

footstool

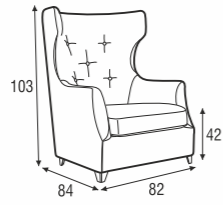

armchair high

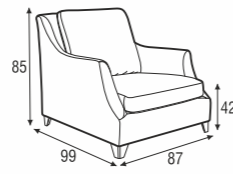

armchair

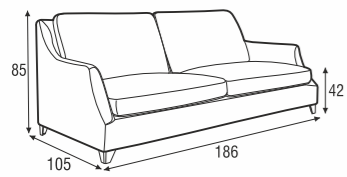

2 seater



3 seater

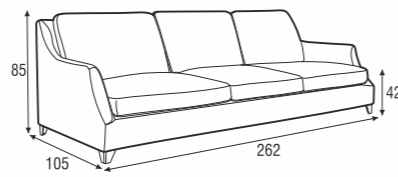

4 seater or 4 seater / two parts

Available in fabric or leather.

Sara

>page 146

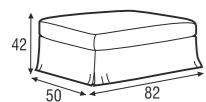

footstool 82x50

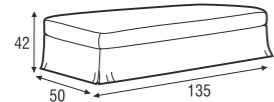

footstool 135x50

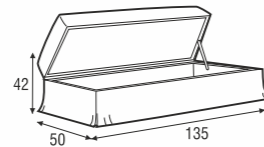

footstool box 135x50

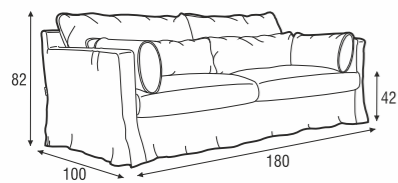

2 seater

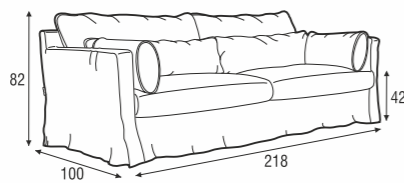

3 seater

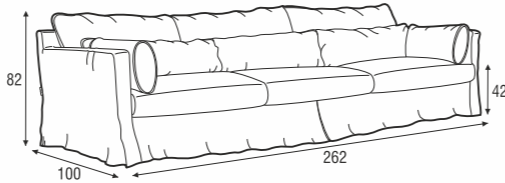

4 seater two parts
screw connection

>>sara

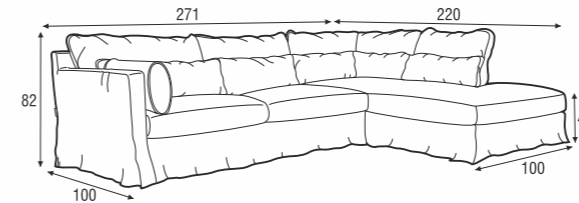

set 1 right / or left

divan right / or left + 2 seater left / or right

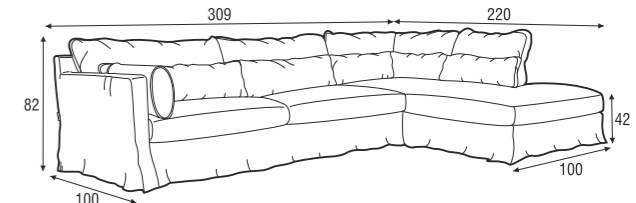

set 2 right / or left

divan right / or left + 3 seater left / or right

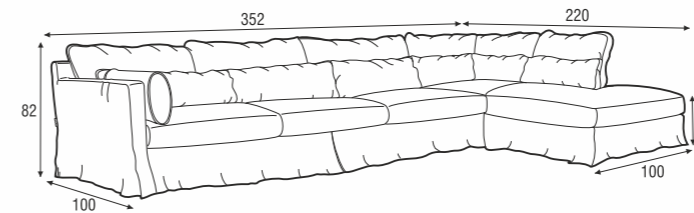

set 3 right / or left

divan right / or left + 4 seater two parts left / or right

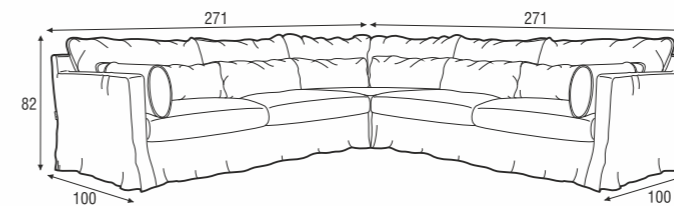

set 4

2 seater left + corner 90° + 2 seater right

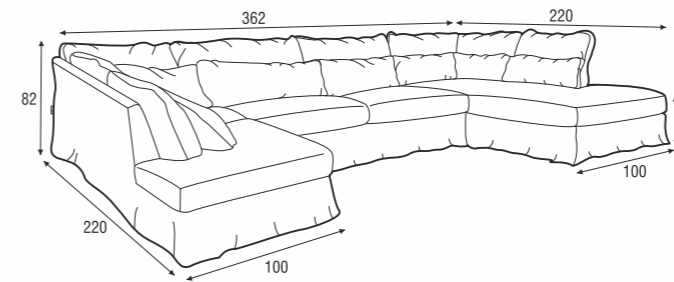

set 5

divan left + 2 seater without armrests + divan right

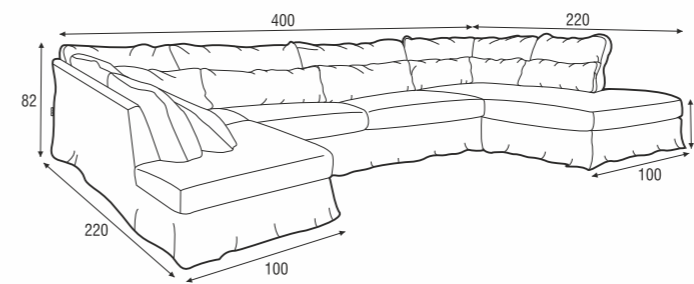

set 6

divan left + 3 seater without armrests + divan right



Anna Näsström & Oscar Näsström



Sits Sp. z o.o.
ul. Gen. Sikorskiego 60,
87-300 Brodnica
tel./fax: +48 56 49 30 700

www.sits.eu
www.facebook.com/sitseu



01 2016

